

## B-45 AETNA

Thrust ball bearings

TYPE: Ball bearings, Thrust ball bearing, Single direction, Separable, flat raceway, inch size

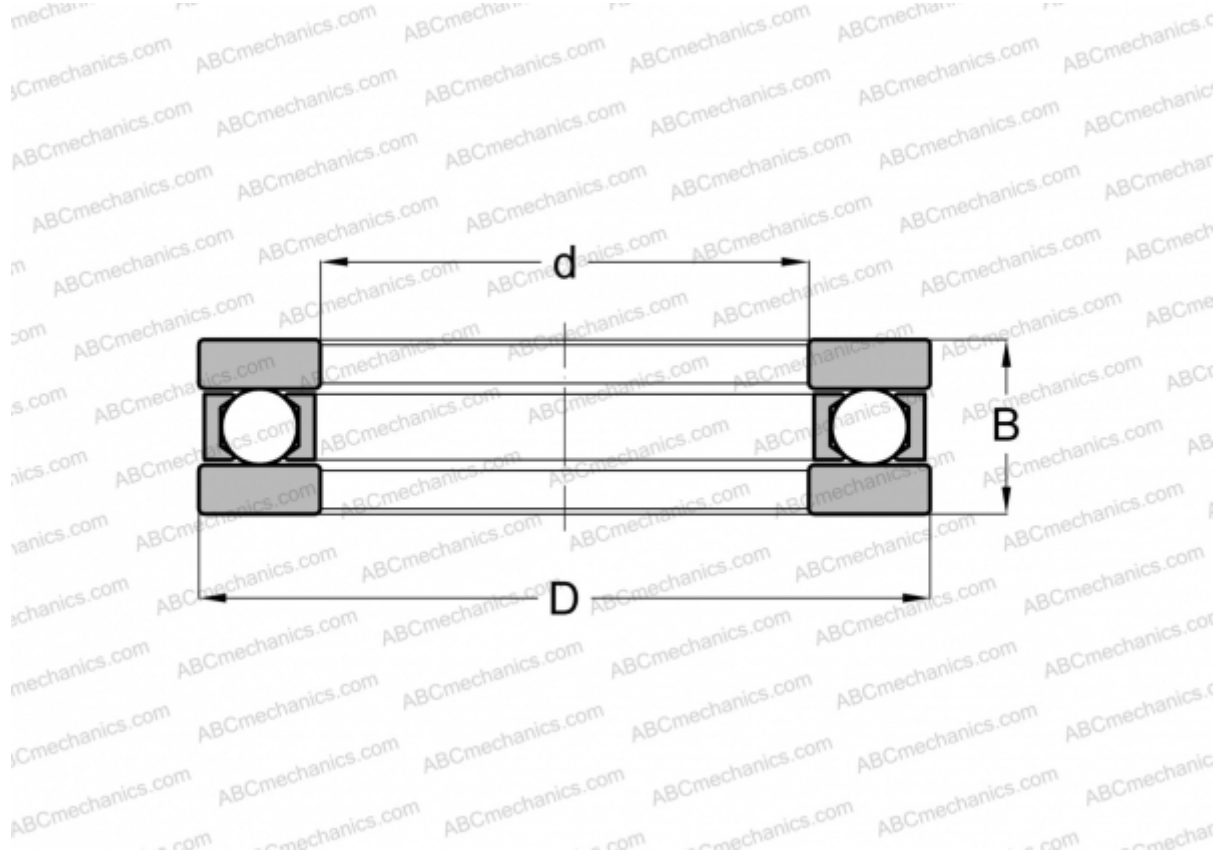

### Technical specification

#### DIMENSIONS, MM

d	88,900
D	132,555
B	25,400

**WEIGHT, KG** 1,270

**MANUFACTURER** [AETNA](#)

#### INTERCHANGE

INA	<a href="#">FT-44</a>
ANDREWS	<a href="#">FT-44</a>