

140BAR10S TYNDBLP4A NSK

Axial angular contact ball bearing

TYPE: Ball bearings, Axial angular contact ball bearing, Single direction, Contact angle 30°, High speed, duplex, light preload (NSK)

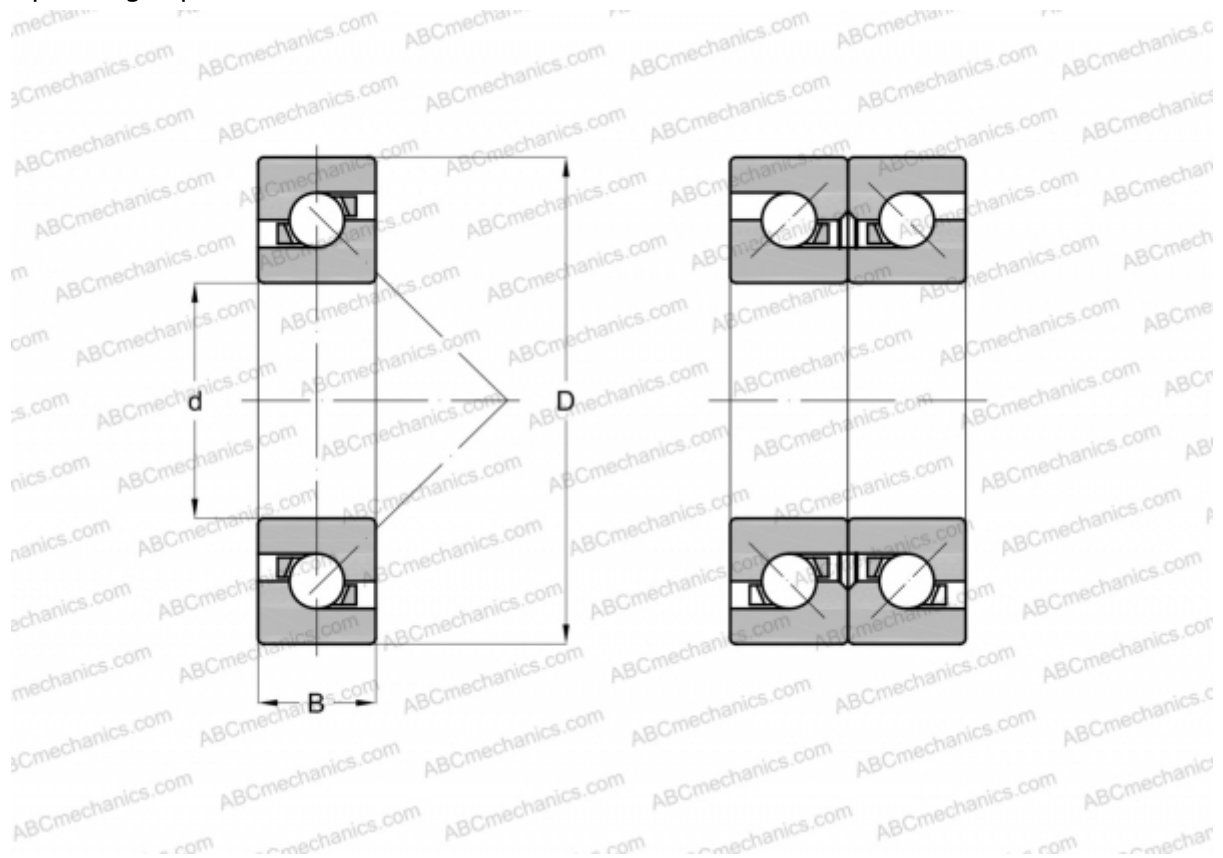

Technical specification

DIMENSIONS, MM

d	140,000
D	210,000
B	31,500

WEIGHT, KG 3,558

MANUFACTURER [NSK](#)