

100BAR10S TYNDBELP4A NSK

TYPE: Ball bearings, Axial angular contact ball bearing, Single direction, Contact angle 30°, High speed, duplex, extra light preload (NSK)

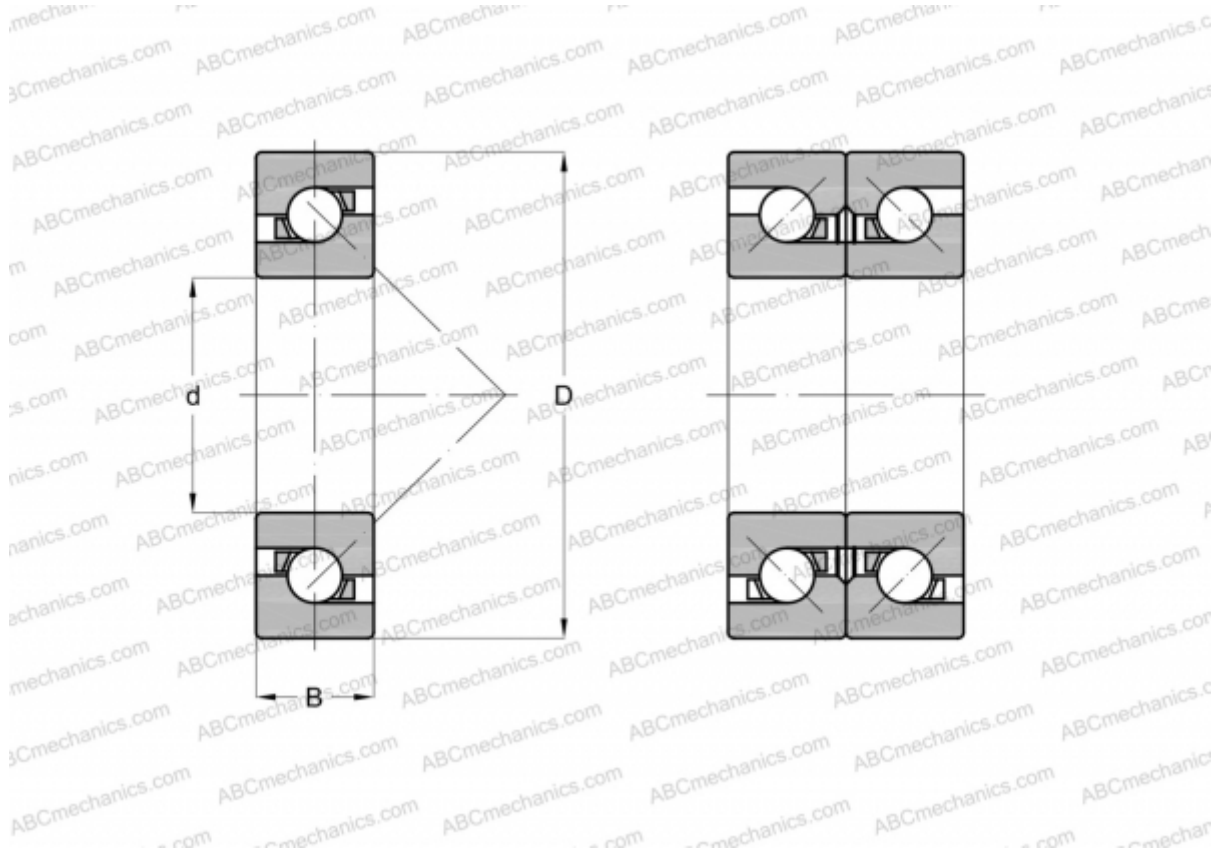

Technical specification

DIMENSIONS, MM

d	100,000
D	150,000
B	22,500

WEIGHT, KG 1,399

MANUFACTURER [NSK](#)