

110BAR10S TYNDBELP4A NSK

TYPE: Ball bearings, Axial angular contact ball bearing, Single direction, Contact angle 30°, High speed, duplex, extra light preload (NSK)

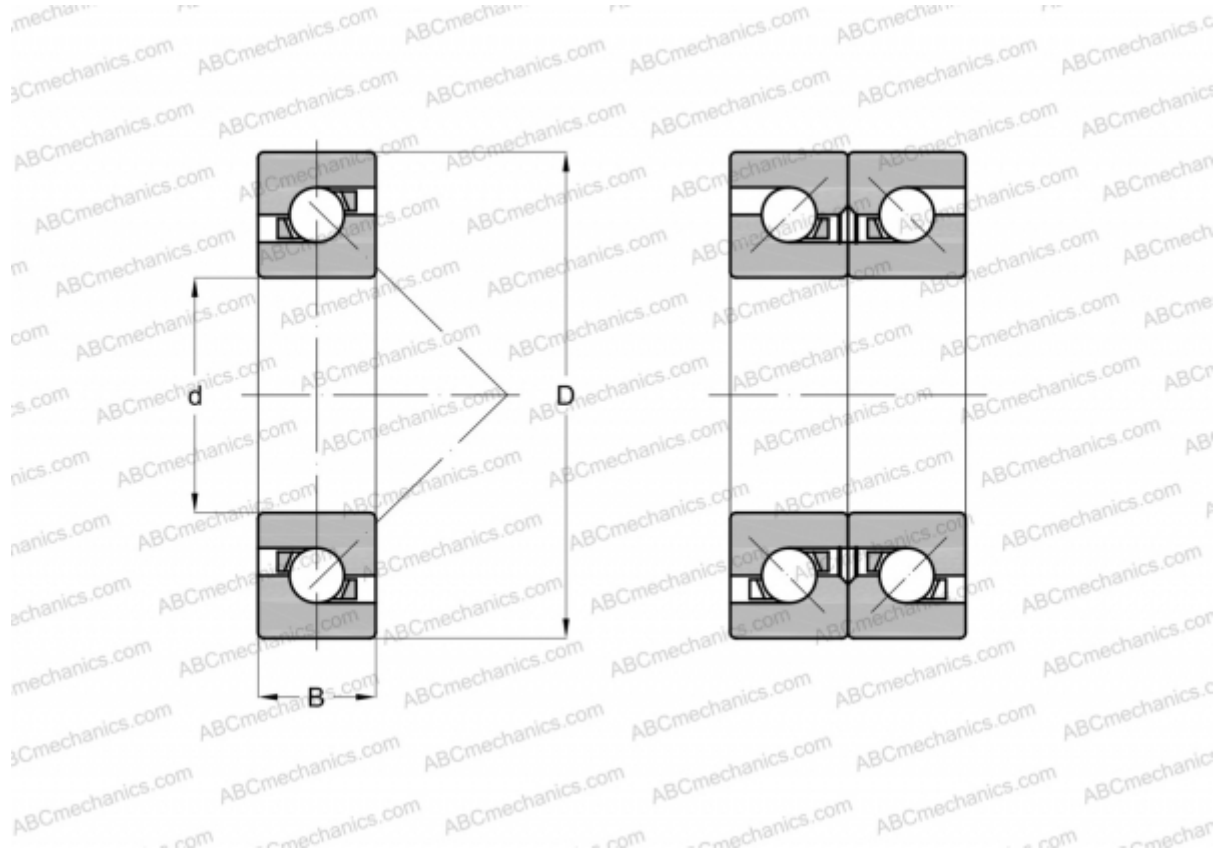

Technical specification

DIMENSIONS, MM

d	110,000
D	170,000
B	27,000

WEIGHT, KG 2,110

MANUFACTURER [NSK](#)