

150BAR10S TYNDBELP4A NSK

TYPE: Ball bearings, Axial angular contact ball bearing, Single direction, Contact angle 30°, High speed, duplex, extra light preload (NSK)

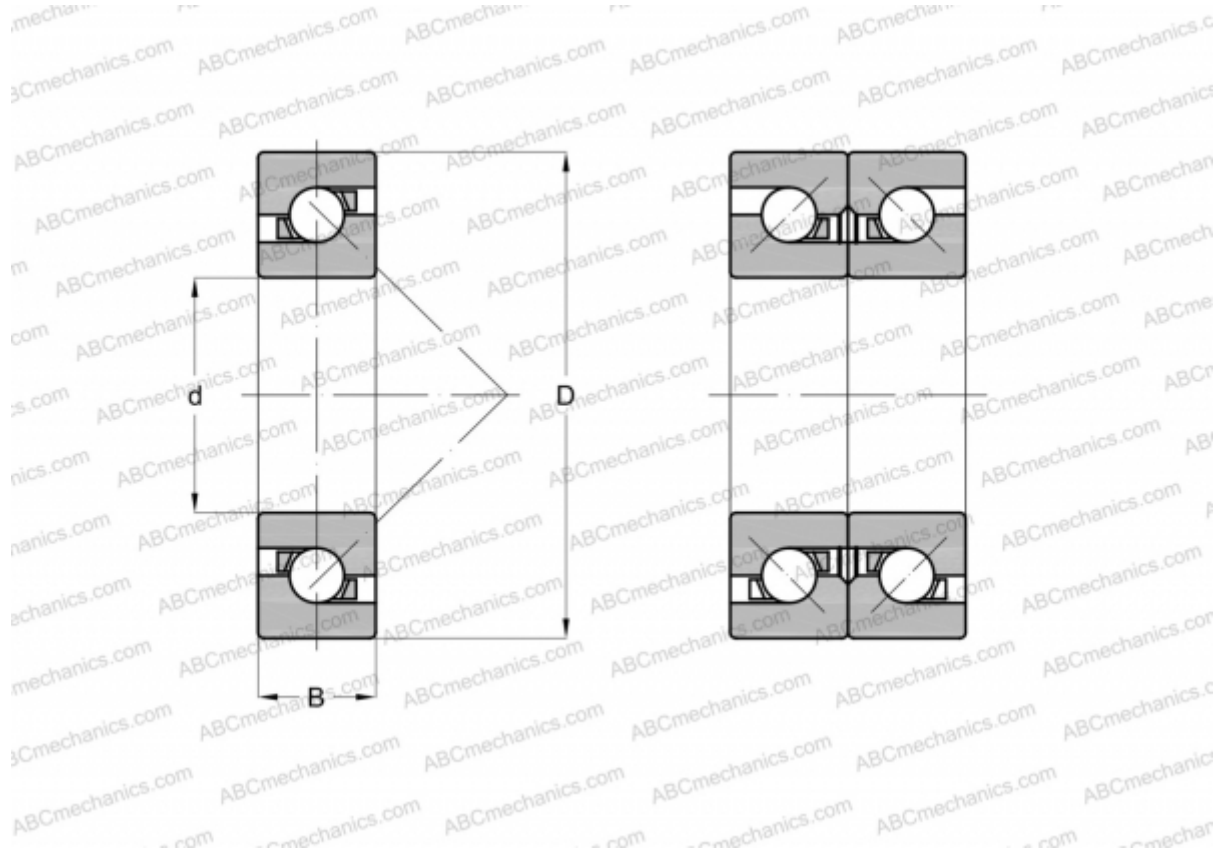

Technical specification

DIMENSIONS, MM

d	150,000
D	225,000
B	33,750

WEIGHT, KG 4,354

MANUFACTURER [NSK](#)