

55BAR10H TYNDBLP4A NSK

TYPE: Ball bearings, Axial angular contact ball bearing, Single direction, Contact angle 30°, High speed, ceramic ball, duplex, light preload (NSK)

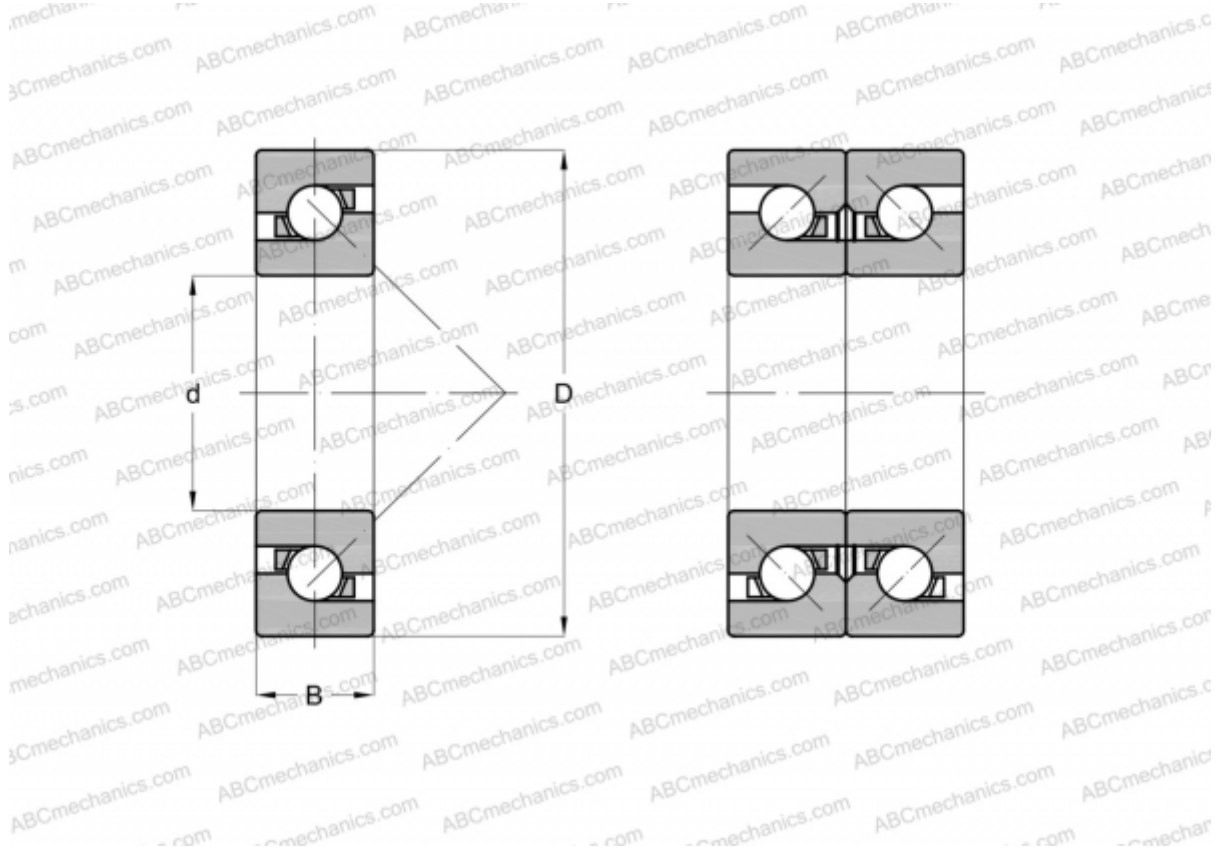

Technical specification

DIMENSIONS, MM

d	55,000
D	90,000
B	16,500

WEIGHT, KG 0,391

MANUFACTURER [NSK](#)