

85BAR10H TYNDBLP4A NSK

TYPE: Ball bearings, Axial angular contact ball bearing, Single direction, Contact angle 30°, High speed, ceramic ball, duplex, light preload (NSK)

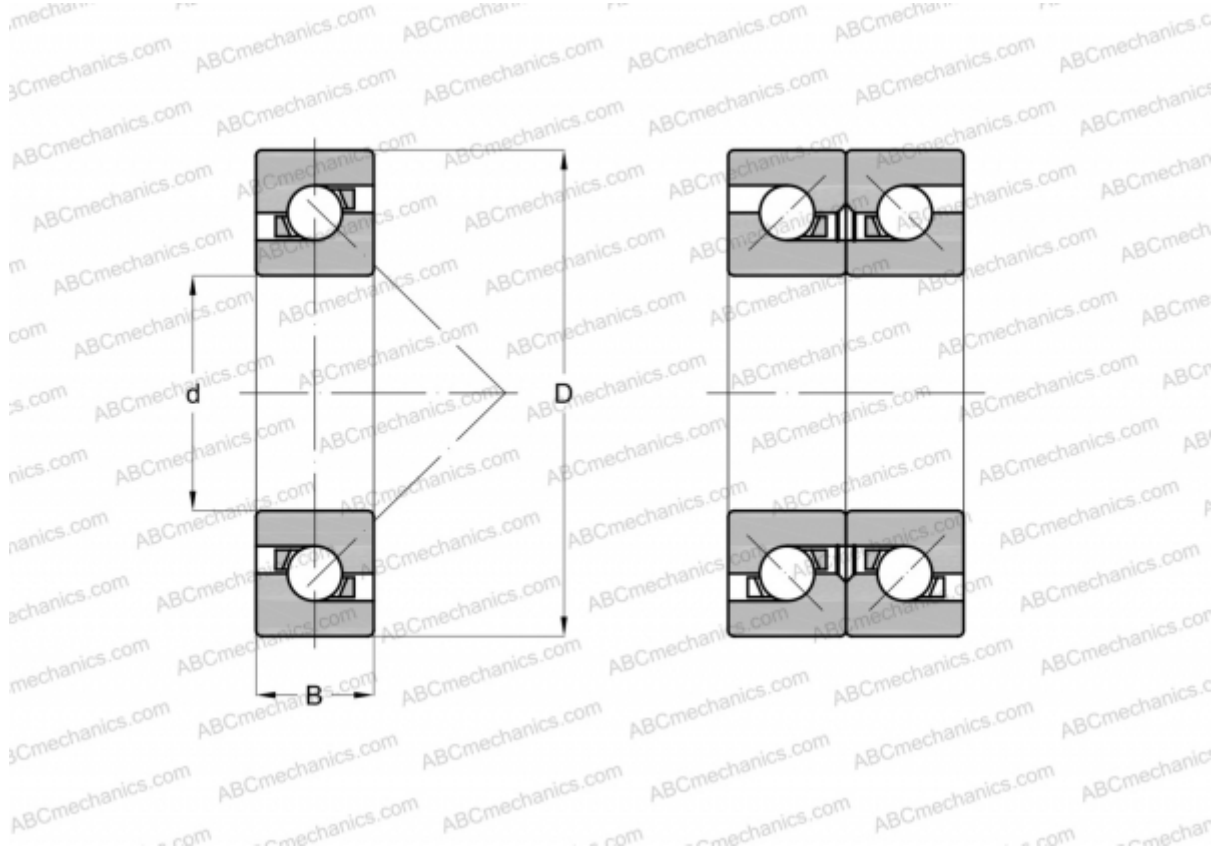

Technical specification

DIMENSIONS, MM

d	85,000
D	130,000
B	20,250

WEIGHT, KG 0,915

MANUFACTURER [NSK](#)