

90BAR10H TYNDBLP4A NSK

TYPE: Ball bearings, Axial angular contact ball bearing, Single direction, Contact angle 30°, High speed, ceramic ball, duplex, light preload (NSK)

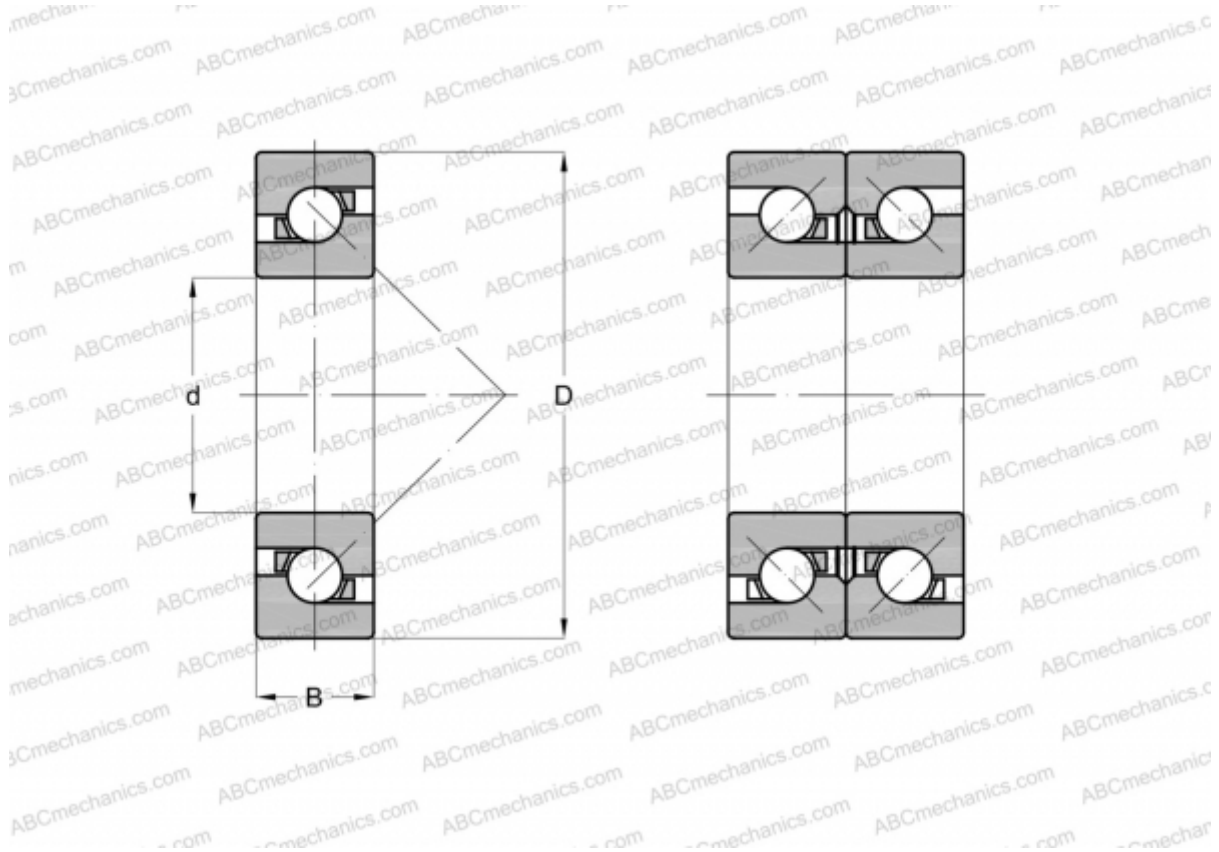

Technical specification

DIMENSIONS, MM

d	90,000
D	140,000
B	22,500

WEIGHT, KG 1,124

MANUFACTURER [NSK](#)