

120BAR10H TYNDBLP4A NSK

TYPE: Ball bearings, Axial angular contact ball bearing, Single direction, Contact angle 30°, High speed, ceramic ball, duplex, light preload (NSK)

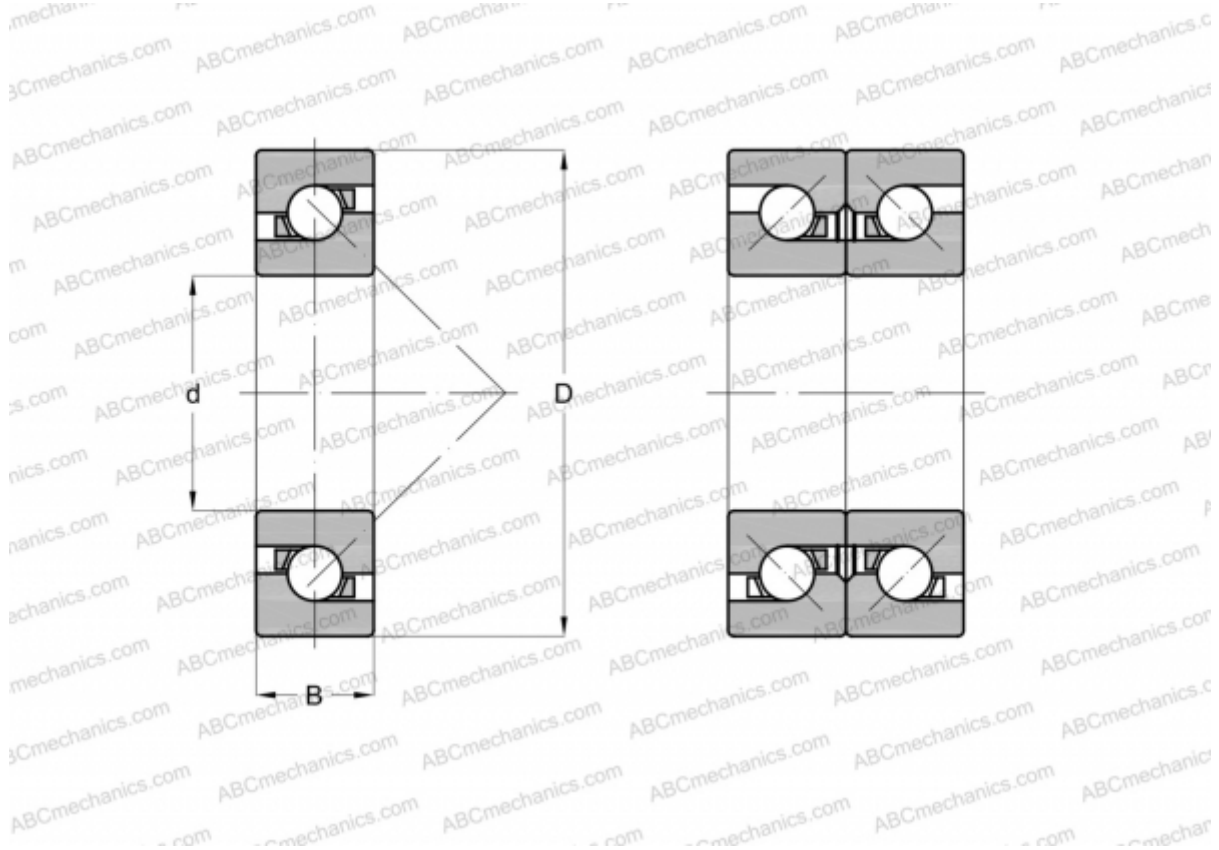

Technical specification

DIMENSIONS, MM

d	120,000
D	180,000
B	27,000

WEIGHT, KG 2,114

MANUFACTURER [NSK](#)