

## 130BAR10H TYNDBLP4A NSK

TYPE: Ball bearings, Axial angular contact ball bearing, Single direction, Contact angle 30°, High speed, ceramic ball, duplex, light preload (NSK)

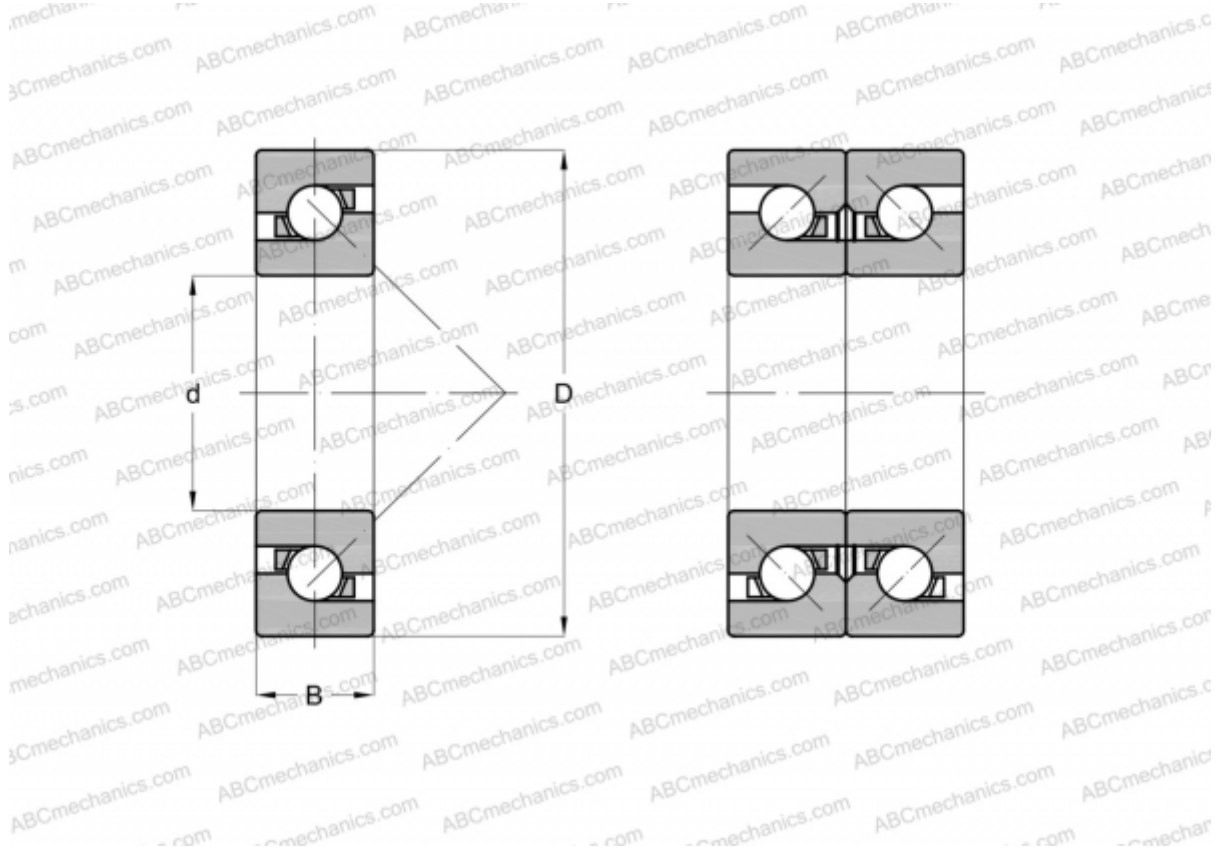

### Technical specification

#### DIMENSIONS, MM

d	130,000
D	200,000
B	31,500

**WEIGHT, KG** 3,148

**MANUFACTURER** [NSK](#)