

## 50BAR10H TYNDBELP4A NSK

TYPE: Ball bearings, Axial angular contact ball bearing, Single direction, Contact angle 30°, High speed, duplex, ceramic ball, extra light preload (NSK)

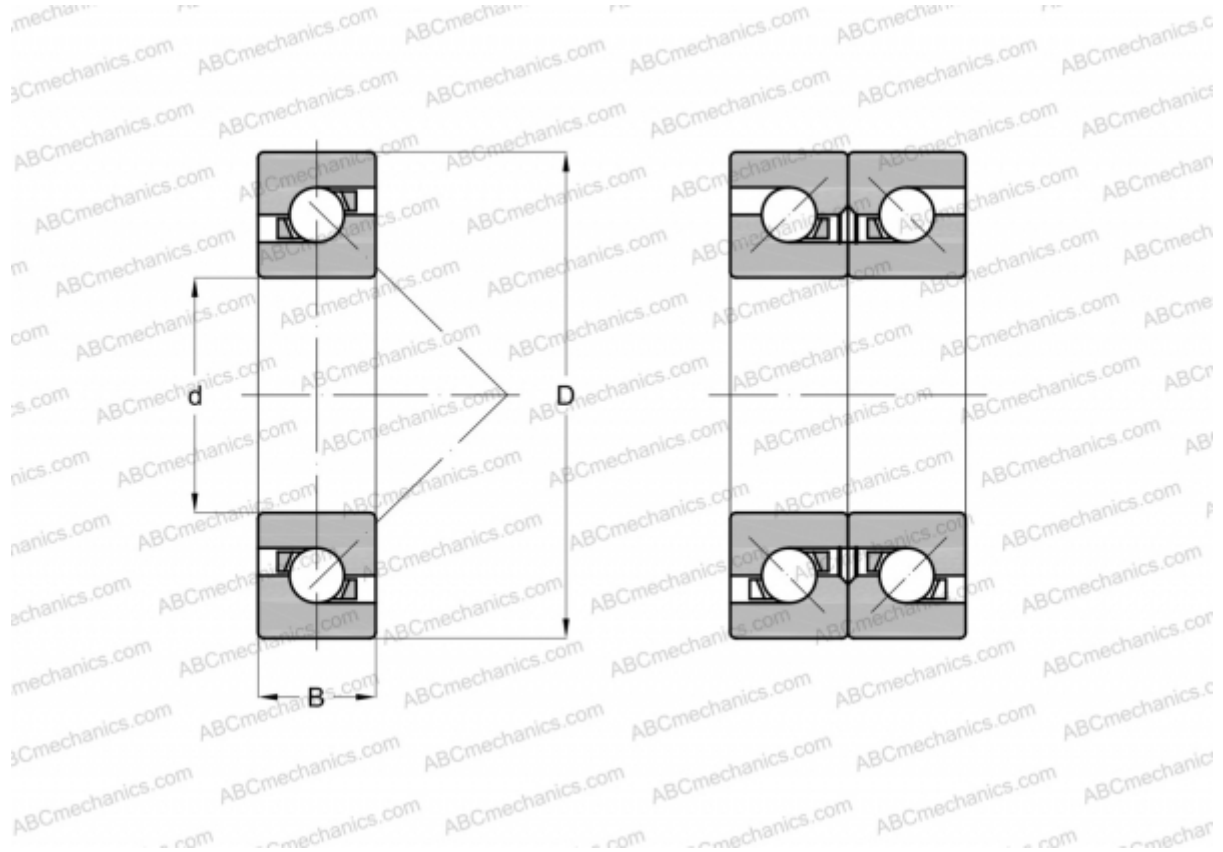

### Technical specification

#### DIMENSIONS, MM

d	50,000
D	80,000
B	14,250

**WEIGHT, KG** 0,257

**MANUFACTURER** [NSK](#)