

## 60BAR10H TYNDBELP4A NSK

TYPE: Ball bearings, Axial angular contact ball bearing, Single direction, Contact angle 30°, High speed, duplex, ceramic ball, extra light preload (NSK)

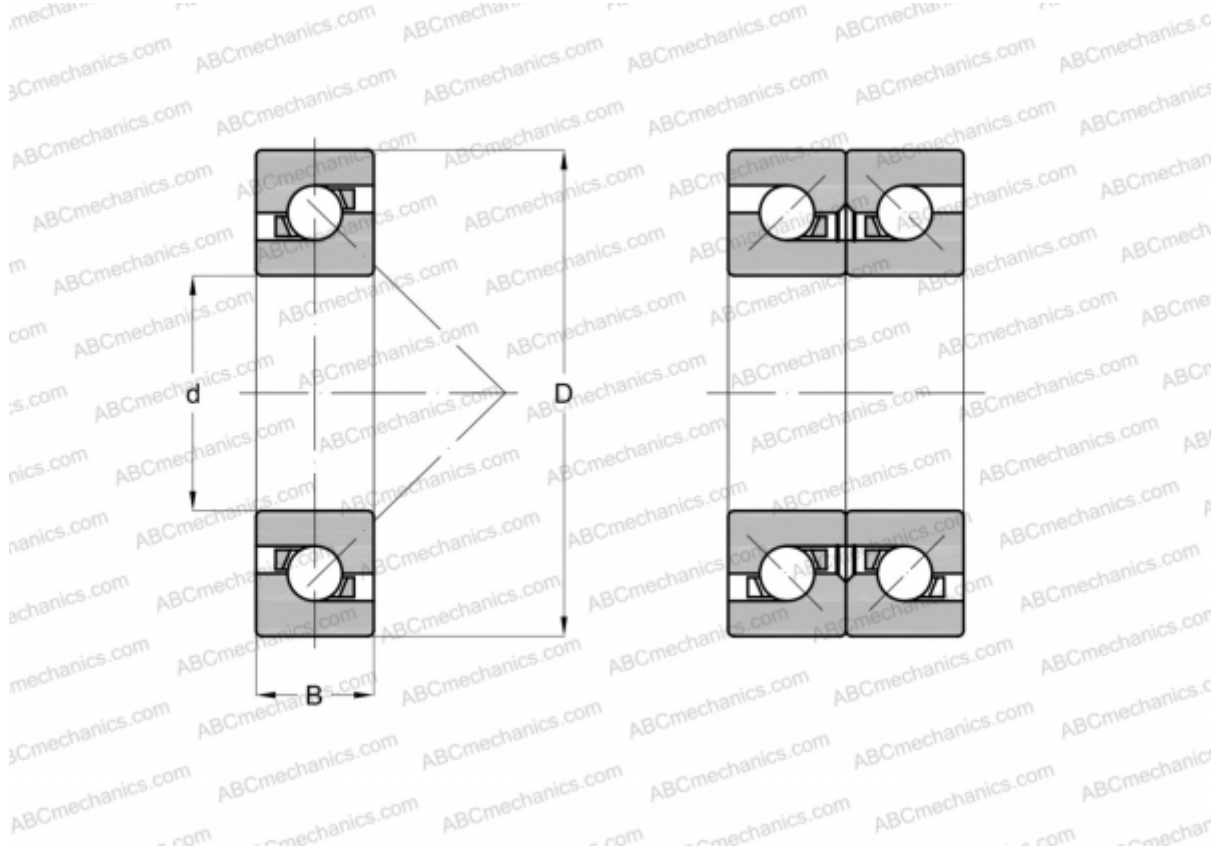

### Technical specification

#### DIMENSIONS, MM

d	60,000
D	95,000
B	16,500

**WEIGHT, KG** 0,397

**MANUFACTURER** [NSK](#)