

75BAR10H TYNDBELP4A NSK

TYPE: Ball bearings, Axial angular contact ball bearing, Single direction, Contact angle 30°, High speed, duplex, ceramic ball, extra light preload (NSK)

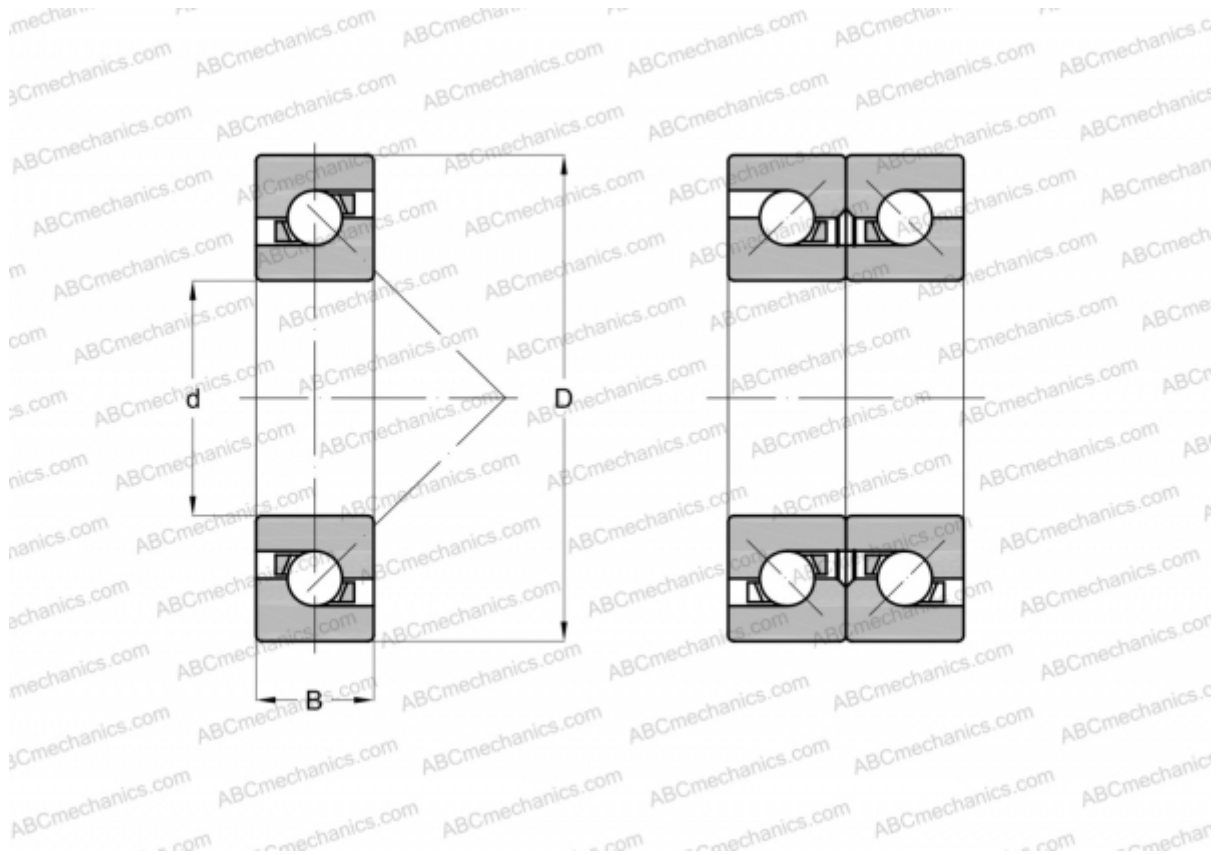

Technical specification

DIMENSIONS, MM

d	75,000
D	115,000
B	18,000

WEIGHT, KG 0,592

MANUFACTURER [NSK](#)