

## 95BAR10H TYNDBELP4A NSK

TYPE: Ball bearings, Axial angular contact ball bearing, Single direction, Contact angle 30°, High speed, duplex, ceramic ball, extra light preload (NSK)

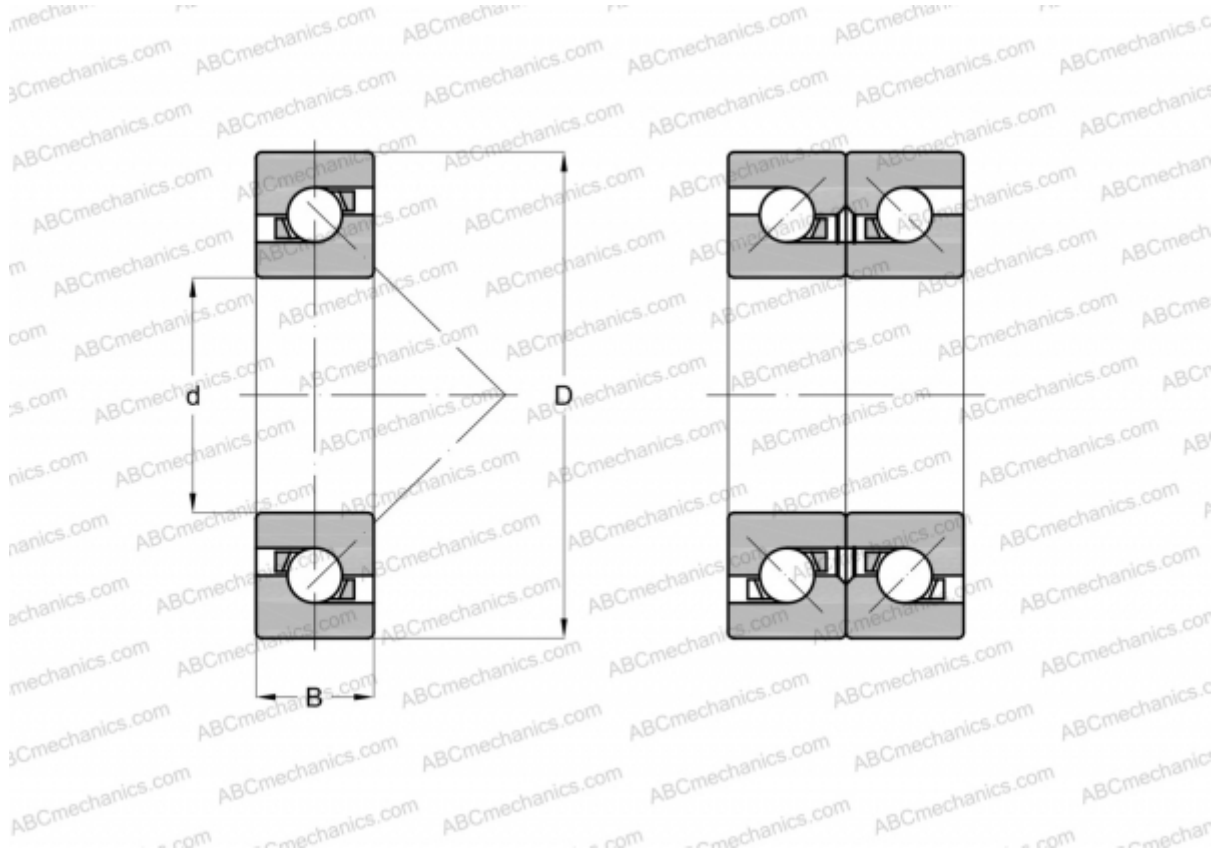

### Technical specification

#### DIMENSIONS, MM

d	95,000
D	145,000
B	22,500

**WEIGHT, KG** 1,231

**MANUFACTURER** [NSK](#)