

55BTR10S TYNDBLP4A NSK

TYPE: Ball bearings, Axial angular contact ball bearing, Single direction, Contact angle 40°, High speed, duplex, light preload (NSK)

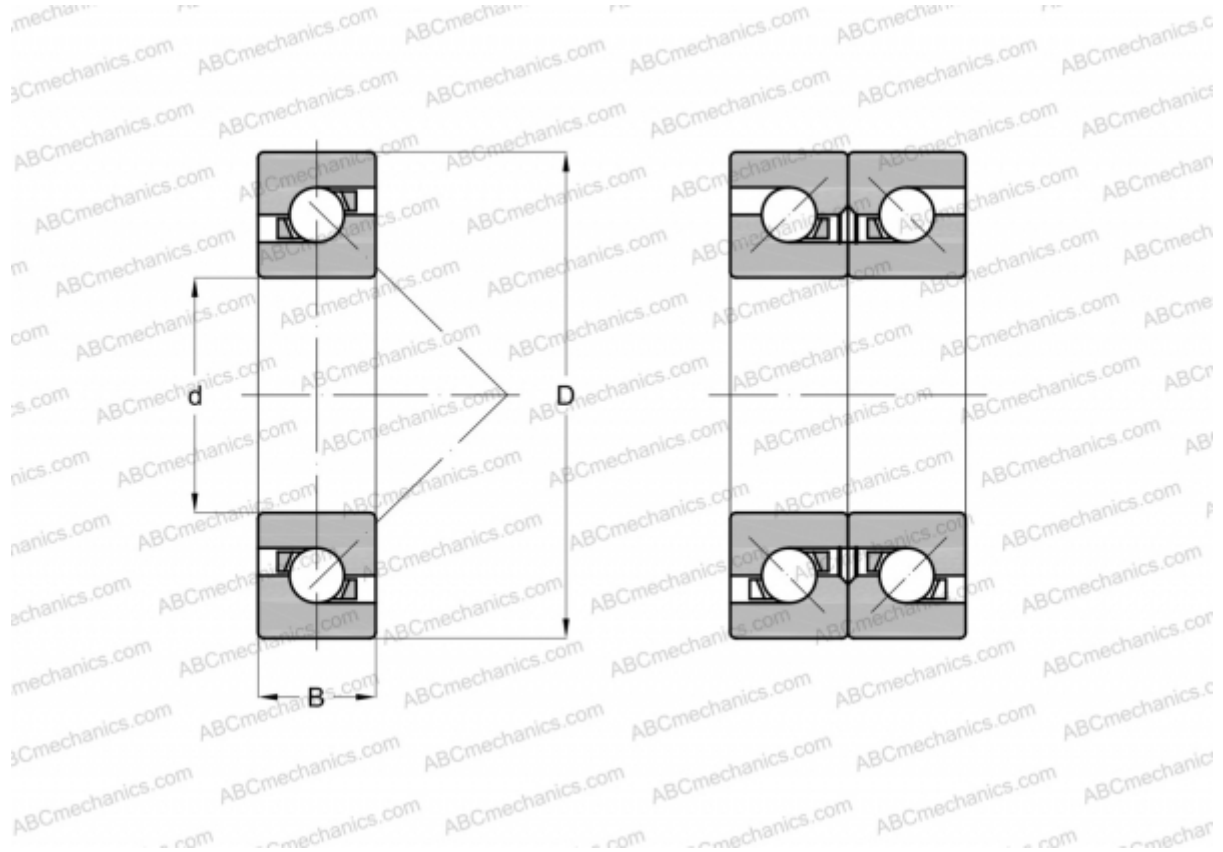

Technical specification

DIMENSIONS, MM

d	55,000
D	90,000
B	16,500

WEIGHT, KG 0,412

MANUFACTURER [NSK](#)