

60BTR10S TYNDBLP4A NSK

TYPE: Ball bearings, Axial angular contact ball bearing, Single direction, Contact angle 40°, High speed, duplex, light preload (NSK)

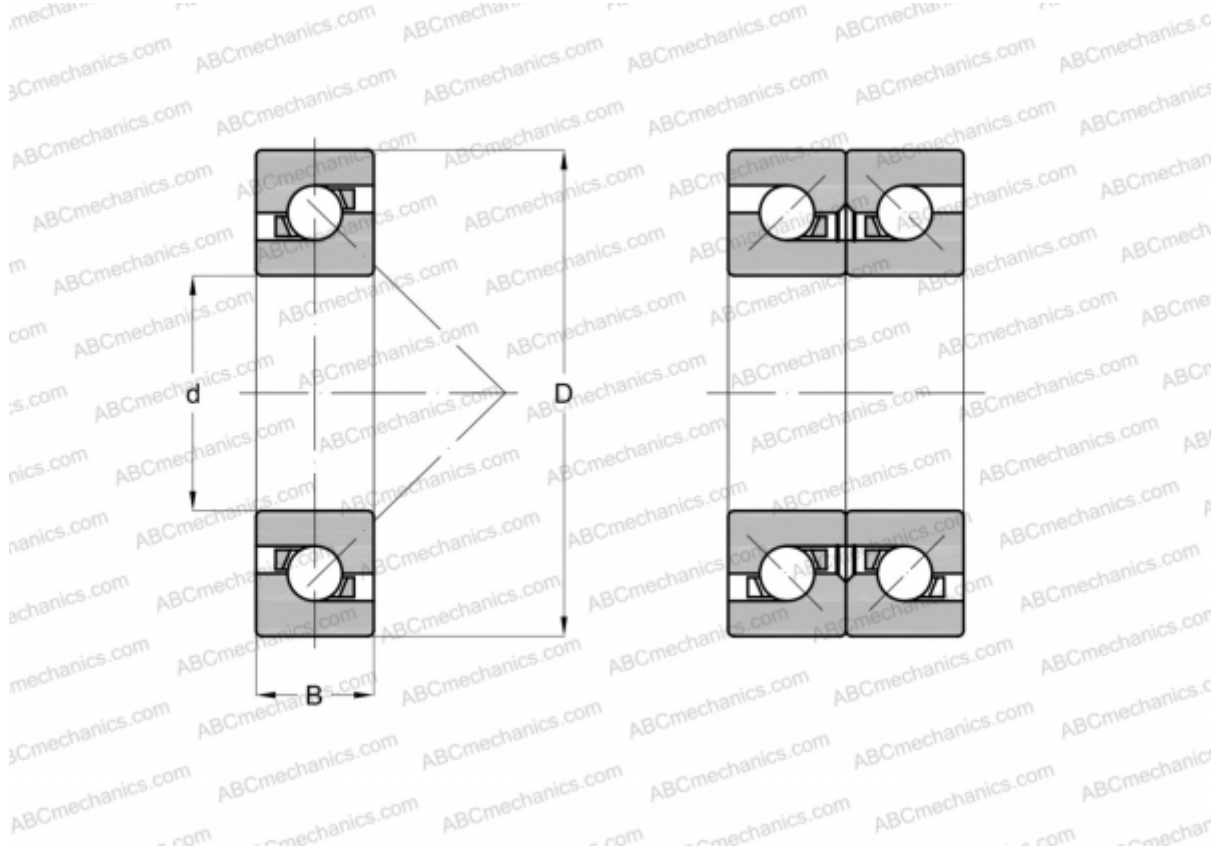

Technical specification

DIMENSIONS, MM

d	60,000
D	95,000
B	16,500

WEIGHT, KG 0,420

MANUFACTURER [NSK](#)