

80BTR10S TYNDBLP4A NSK

TYPE: Ball bearings, Axial angular contact ball bearing, Single direction, Contact angle 40°, High speed, duplex, light preload (NSK)

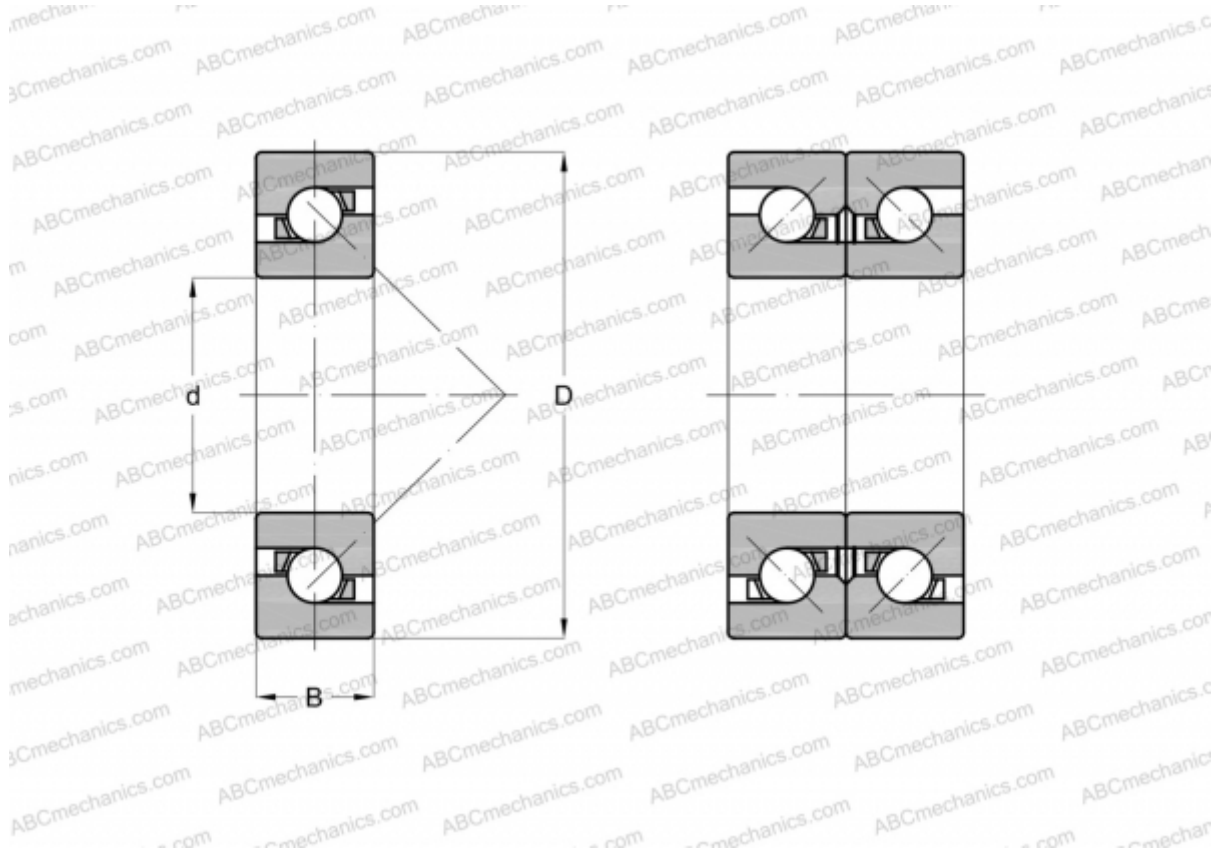

Technical specification

DIMENSIONS, MM

d	80,000
D	125,000
B	20,250

WEIGHT, KG 0,875

MANUFACTURER [NSK](#)