

## 110BTR10S TYNDBLP4A NSK

TYPE: Ball bearings, Axial angular contact ball bearing, Single direction, Contact angle 40°, High speed, duplex, light preload (NSK)

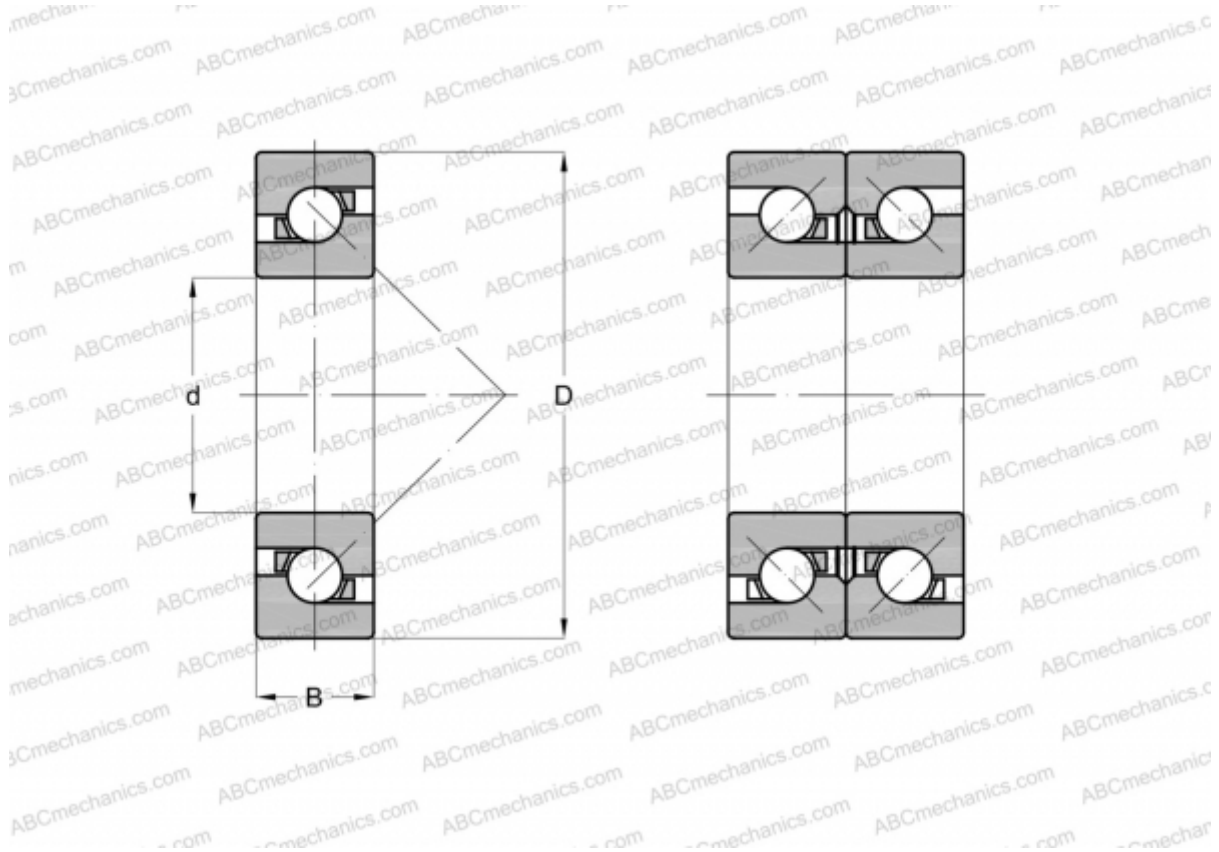

### Technical specification

#### DIMENSIONS, MM

d	110,000
D	170,000
B	27,000

**WEIGHT, KG** 2,110

**MANUFACTURER** [NSK](#)