

## 150BTR10S TYNDBLP4A NSK

TYPE: Ball bearings, Axial angular contact ball bearing, Single direction, Contact angle 40°, High speed, duplex, light preload (NSK)

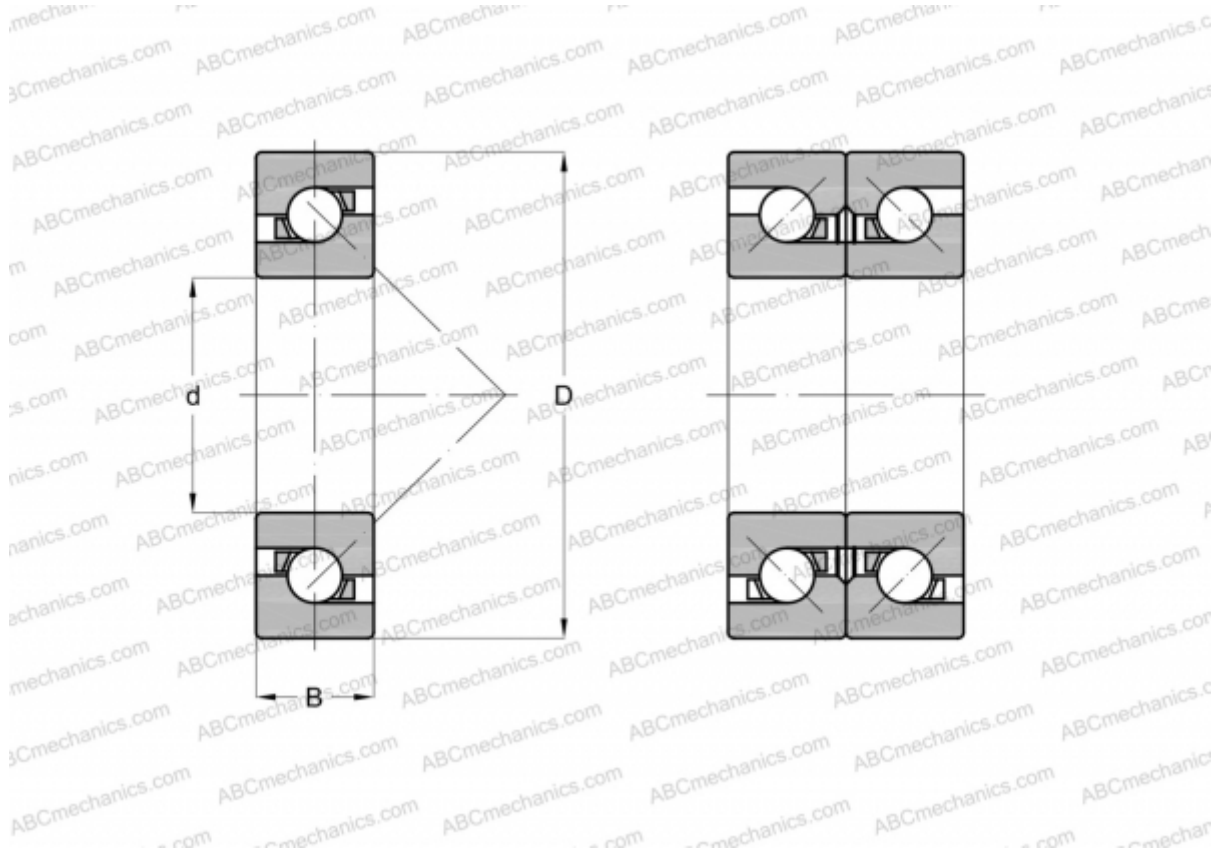

### Technical specification

#### DIMENSIONS, MM

d	150,000
D	225,000
B	33,750

**WEIGHT, KG** 4,354

**MANUFACTURER** [NSK](#)