

105BTR10S TYNDBELP4A NSK

Axial angular contact ball bearing

TYPE: Ball bearings, Axial angular contact ball bearing, Single direction, Contact angle 40°, High speed, duplex, extra light preload (NSK)

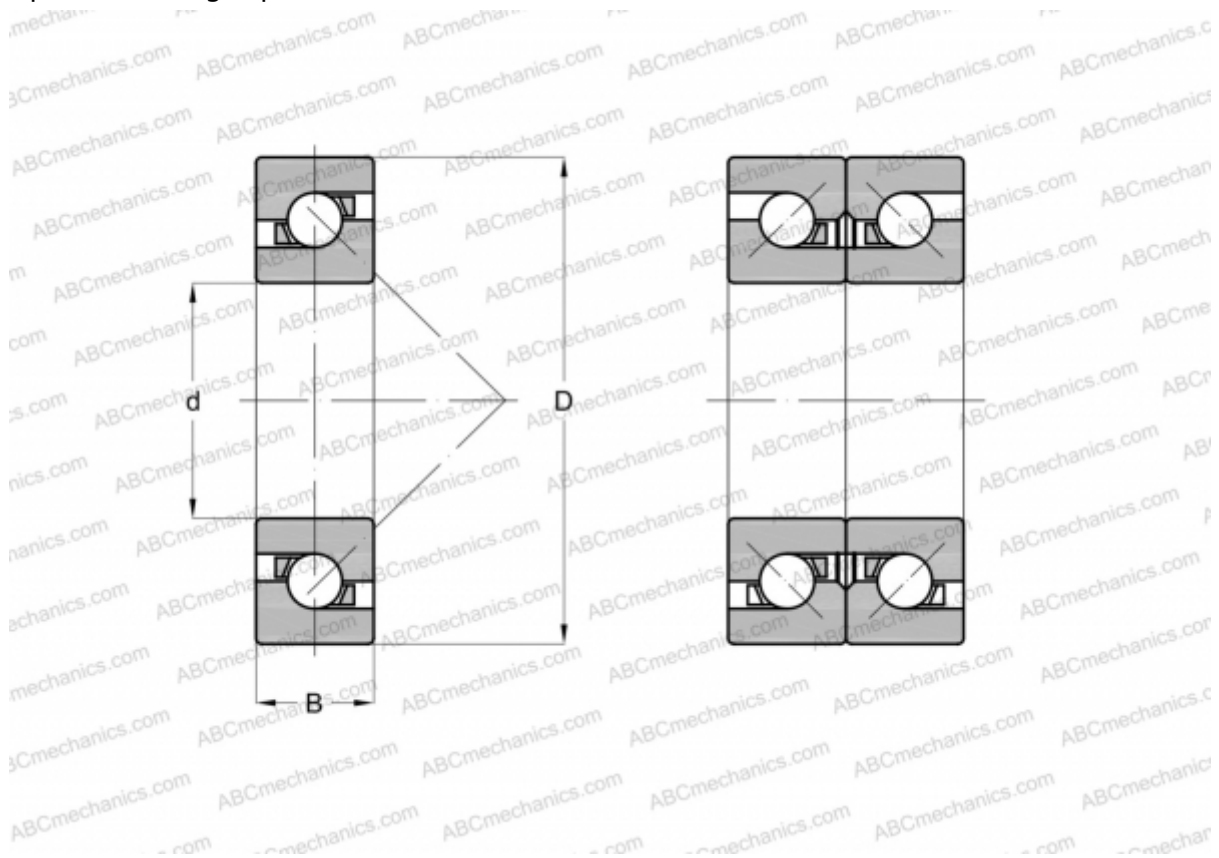

Technical specification

DIMENSIONS, MM

d	105,000
D	160,000
B	24,750

WEIGHT, KG 1,740

MANUFACTURER [NSK](#)