

## 160BTR10S TYNDBELP4A NSK

Axial angular contact ball bearing

TYPE: Ball bearings, Axial angular contact ball bearing, Single direction, Contact angle 40°, High speed, duplex, extra light preload (NSK)

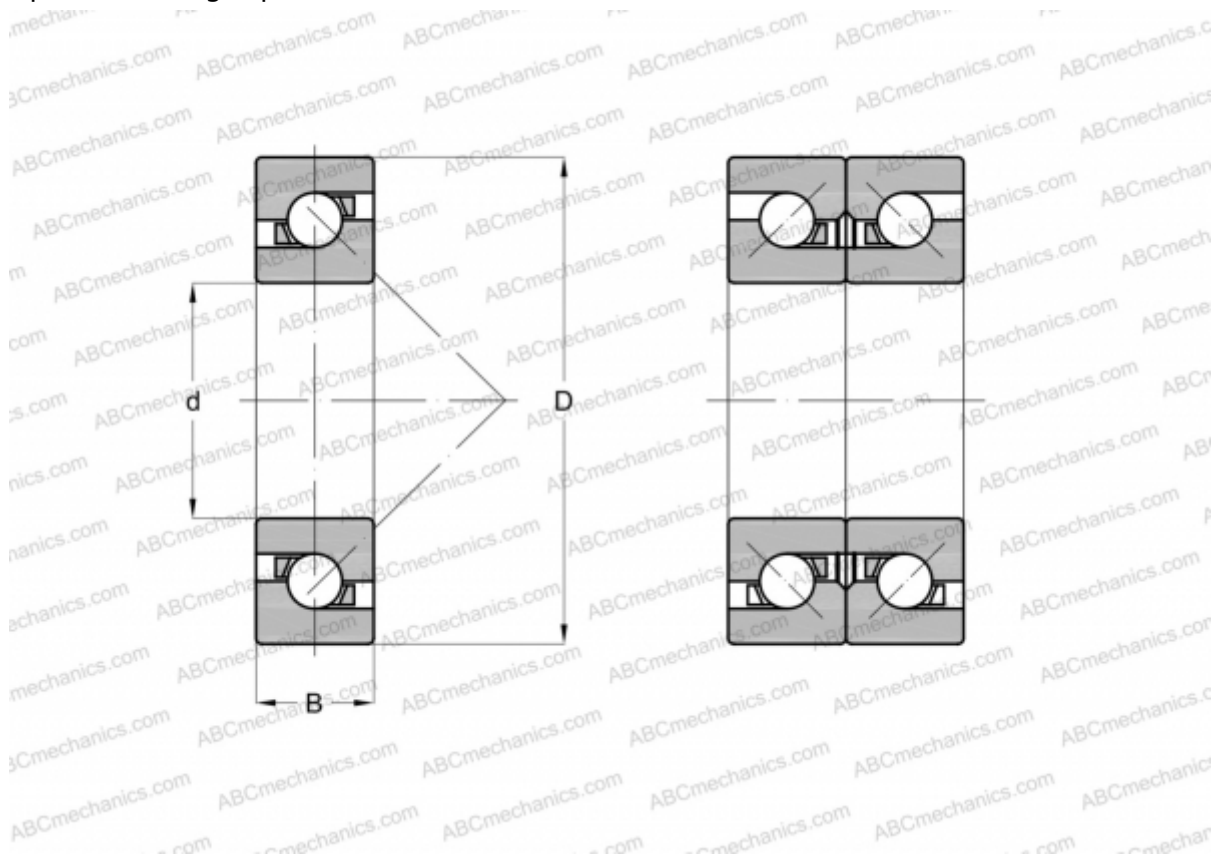

### Technical specification

#### DIMENSIONS, MM

d	160,000
D	240,000
B	36,000

**WEIGHT, KG** 5,640

**MANUFACTURER** [NSK](#)