

## 170BTR10S TYNDBELP4A NSK

Axial angular contact ball bearing

TYPE: Ball bearings, Axial angular contact ball bearing, Single direction, Contact angle 40°, High speed, duplex, extra light preload (NSK)

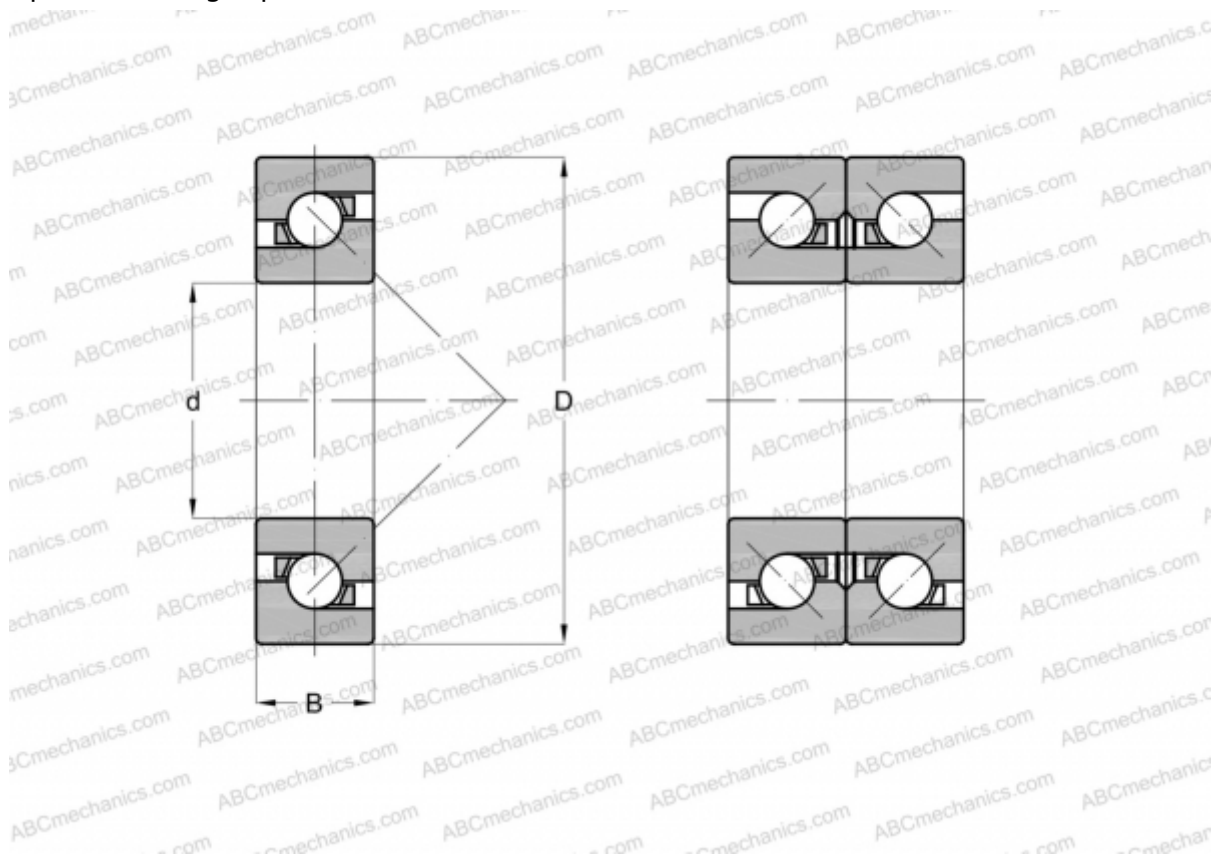

### Technical specification

#### DIMENSIONS, MM

d	170,000
D	260,000
B	40,500

**WEIGHT, KG** 7,900

**MANUFACTURER** [NSK](#)