

190BTR10S TYNDBELP4A NSK

Axial angular contact ball bearing

TYPE: Ball bearings, Axial angular contact ball bearing, Single direction, Contact angle 40°, High speed, duplex, extra light preload (NSK)

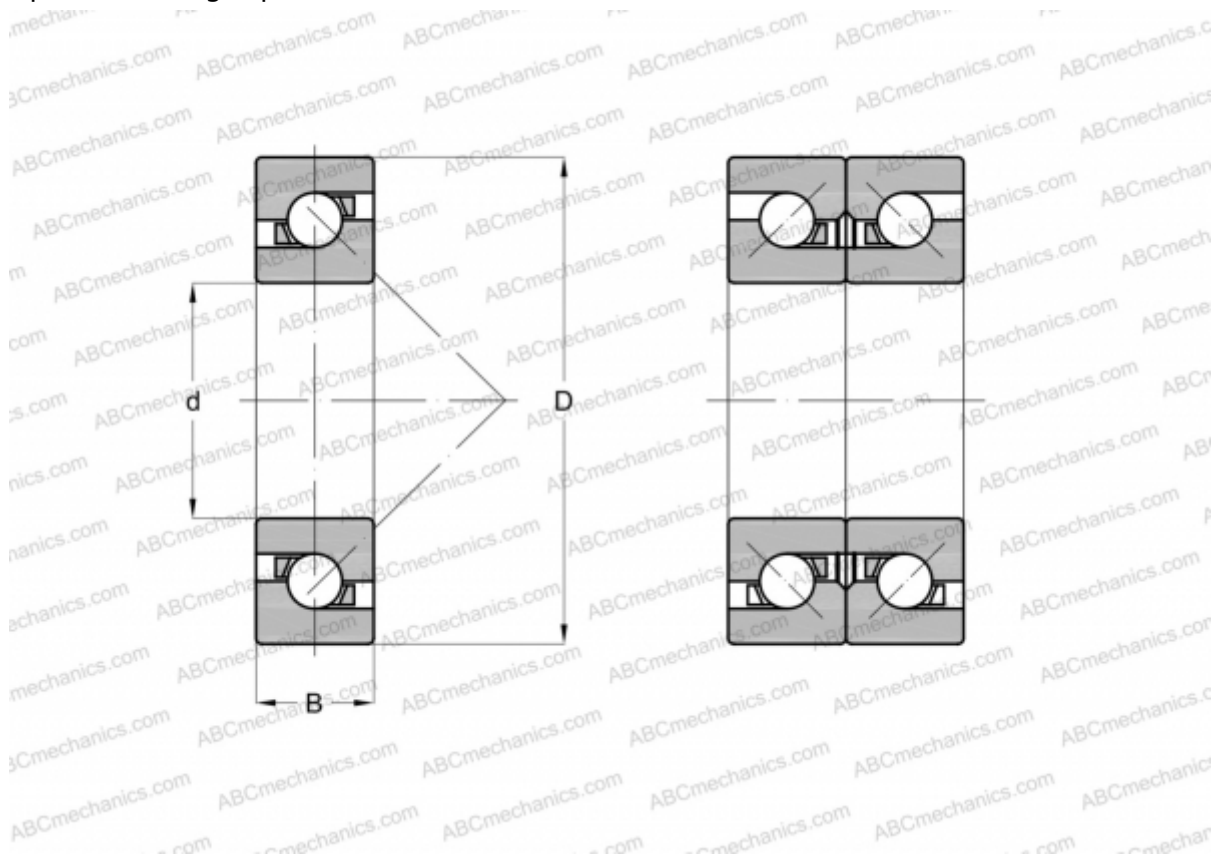

Technical specification

DIMENSIONS, MM

d	190,000
D	290,000
B	45,000

WEIGHT, KG 10,700

MANUFACTURER [NSK](#)