

200BTR10S TYNDBELP4A NSK

Axial angular contact ball bearing

TYPE: Ball bearings, Axial angular contact ball bearing, Single direction, Contact angle 40°, High speed, duplex, extra light preload (NSK)

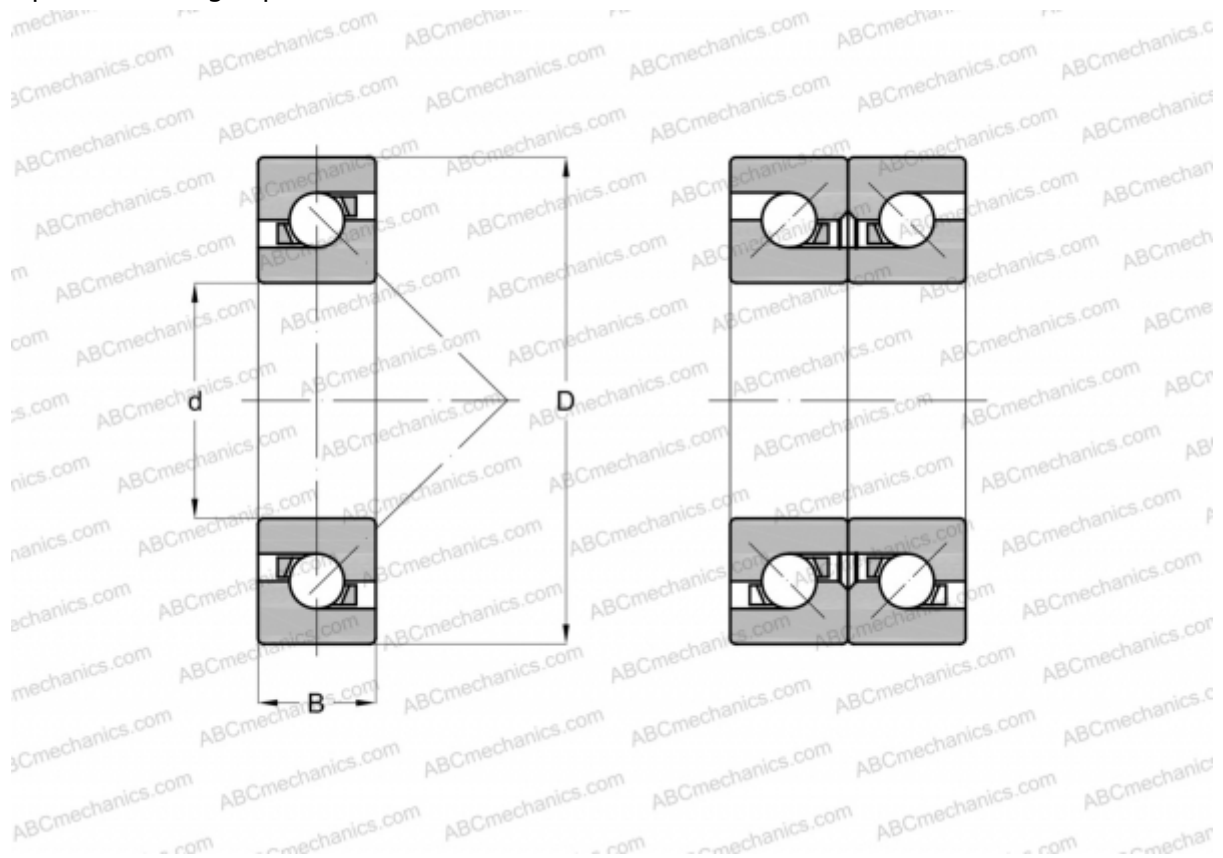

Technical specification

DIMENSIONS, MM

d	200,000
D	310,000
B	49,500

WEIGHT, KG 13,800

MANUFACTURER [NSK](#)