

## 95BTR10H TYNDBLP4A NSK

Axial angular contact ball bearing

TYPE: Ball bearings, Axial angular contact ball bearing, Single direction, Contact angle 40°, High speed, ceramic ball, duplex, light preload (NSK)

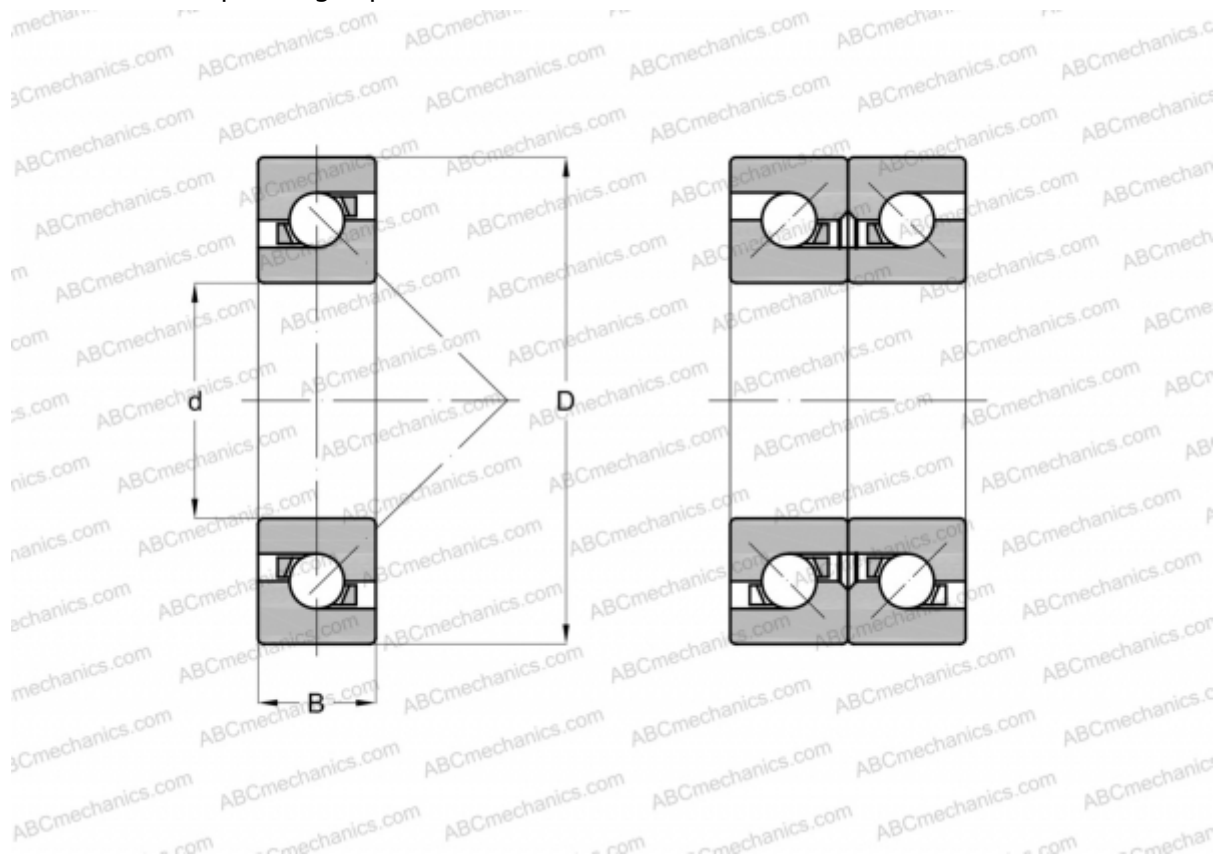

### Technical specification

#### DIMENSIONS, MM

d	95,000
D	145,000
B	22,500

**WEIGHT, KG** 1,231

**MANUFACTURER** [NSK](#)