

60BTR10H TYNDBELP4A NSK

Axial angular contact ball bearing

TYPE: Ball bearings, Axial angular contact ball bearing, Single direction, Contact angle 40°, High speed, duplex, ceramic ball, extra light preload (NSK)

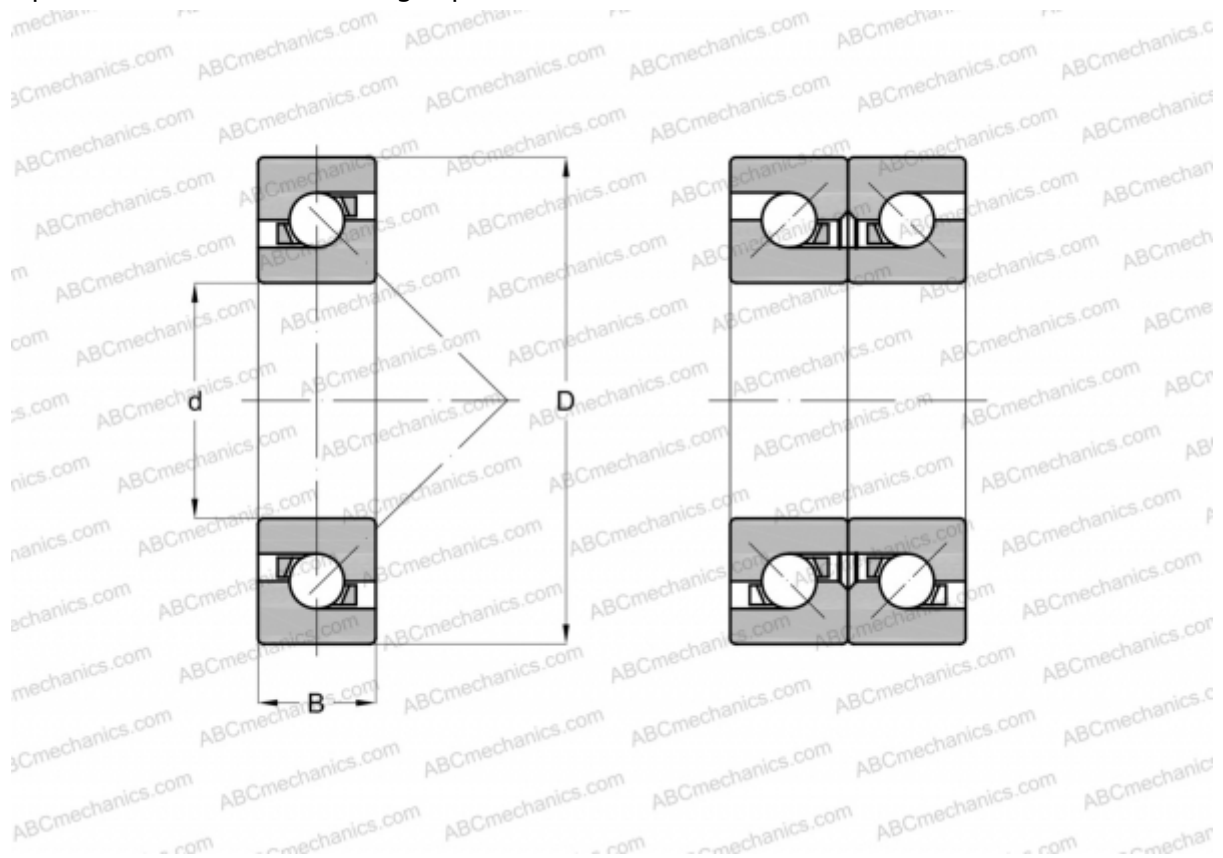

Technical specification

DIMENSIONS, MM

d	60,000
D	95,000
B	16,500

WEIGHT, KG 0,397

MANUFACTURER [NSK](#)