

## 90BTR10H TYNDBELP4A NSK

Axial angular contact ball bearing

TYPE: Ball bearings, Axial angular contact ball bearing, Single direction, Contact angle 40°, High speed, duplex, ceramic ball, extra light preload (NSK)

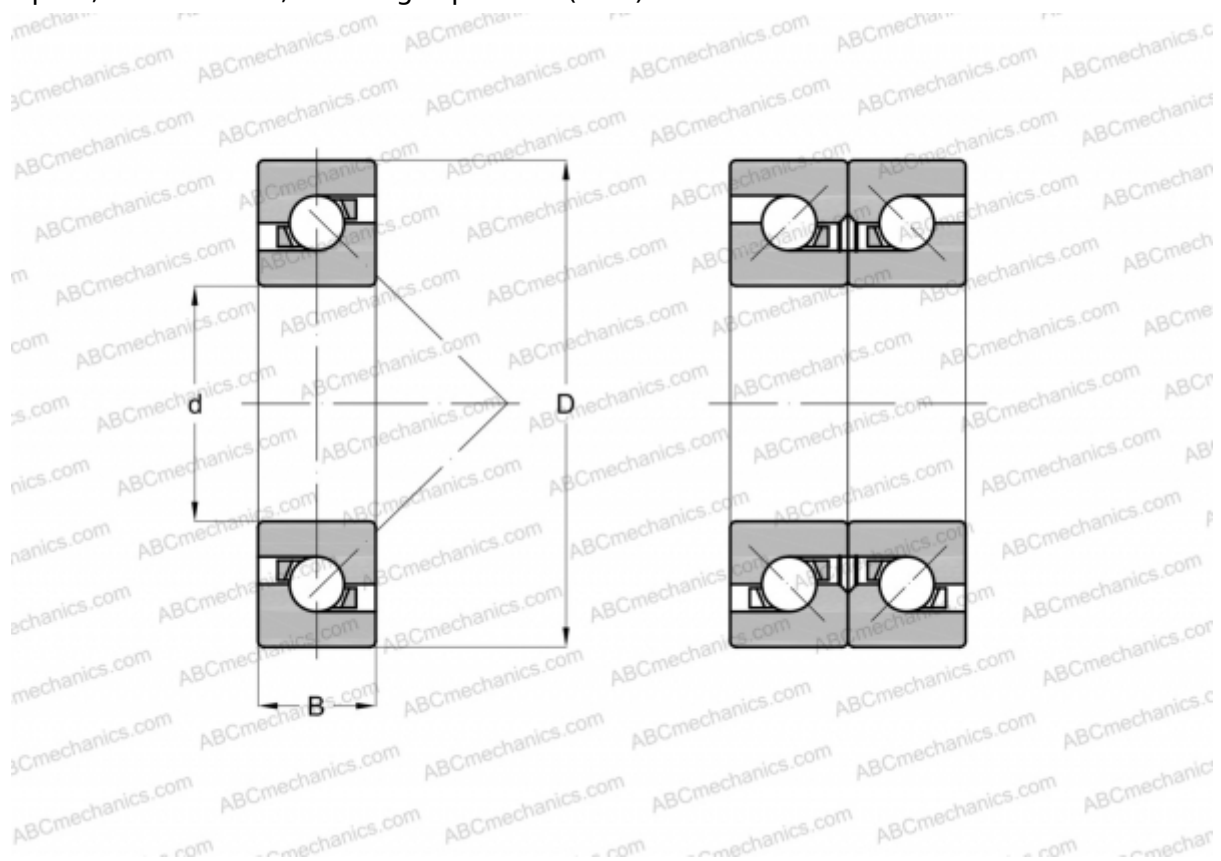

### Technical specification

#### DIMENSIONS, MM

d	90,000
D	140,000
B	22,500

**WEIGHT, KG** 1,124

**MANUFACTURER** [NSK](#)