

BSB3572-SU FAG

Axial angular contact ball bearing

TYPE: Ball bearings, Axial angular contact ball bearing, Single direction, Contact angle 60°, Ball screw support bearings, mounting for pair (FAG)

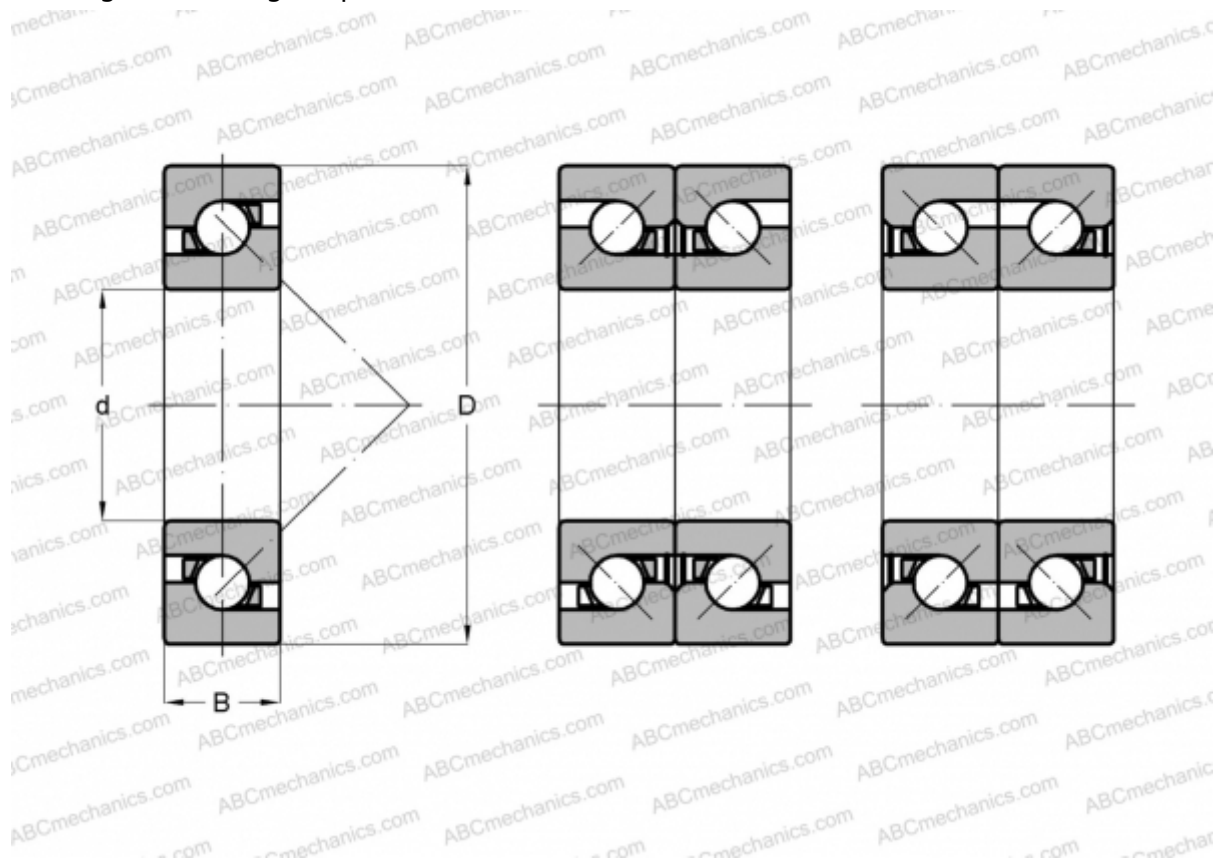

Technical specification

DIMENSIONS, MM

d	35,000
D	72,000
B	15,000

MANUFACTURER

[FAG](#)