

## BSB4072-SU FAG

Axial angular contact ball bearing

TYPE: Ball bearings, Axial angular contact ball bearing, Single direction, Contact angle 60°, Ball screw support bearings, mounting for pair (FAG)

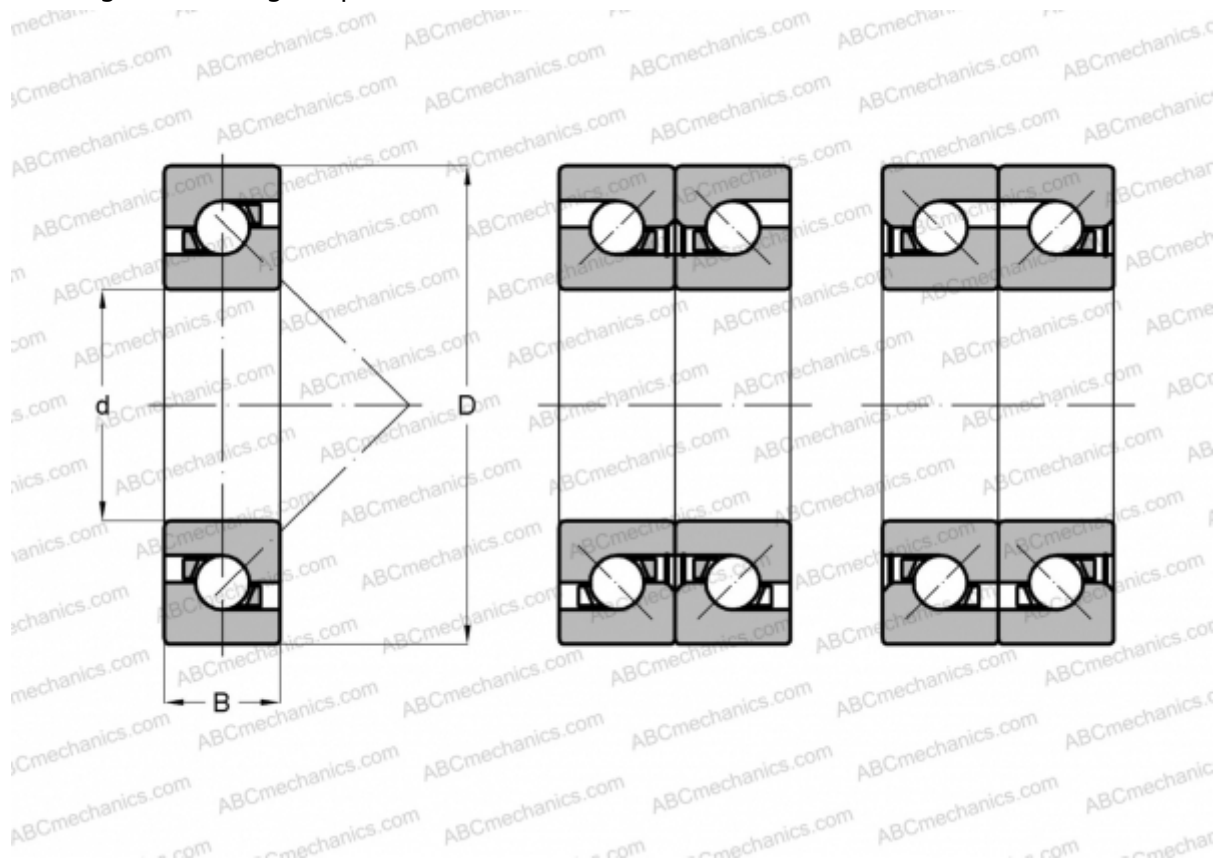

### Technical specification

#### DIMENSIONS, MM

d	40,000
D	72,000
B	15,000

**WEIGHT, KG** 0,260

**MANUFACTURER** [FAG](#)