

ZKLR 1547 2RS INA

Axial angular contact ball bearing

TYPE: Ball bearings, Axial angular contact ball bearing, Unit, Series ZKLR, double direction, with flange, lip seals on both side

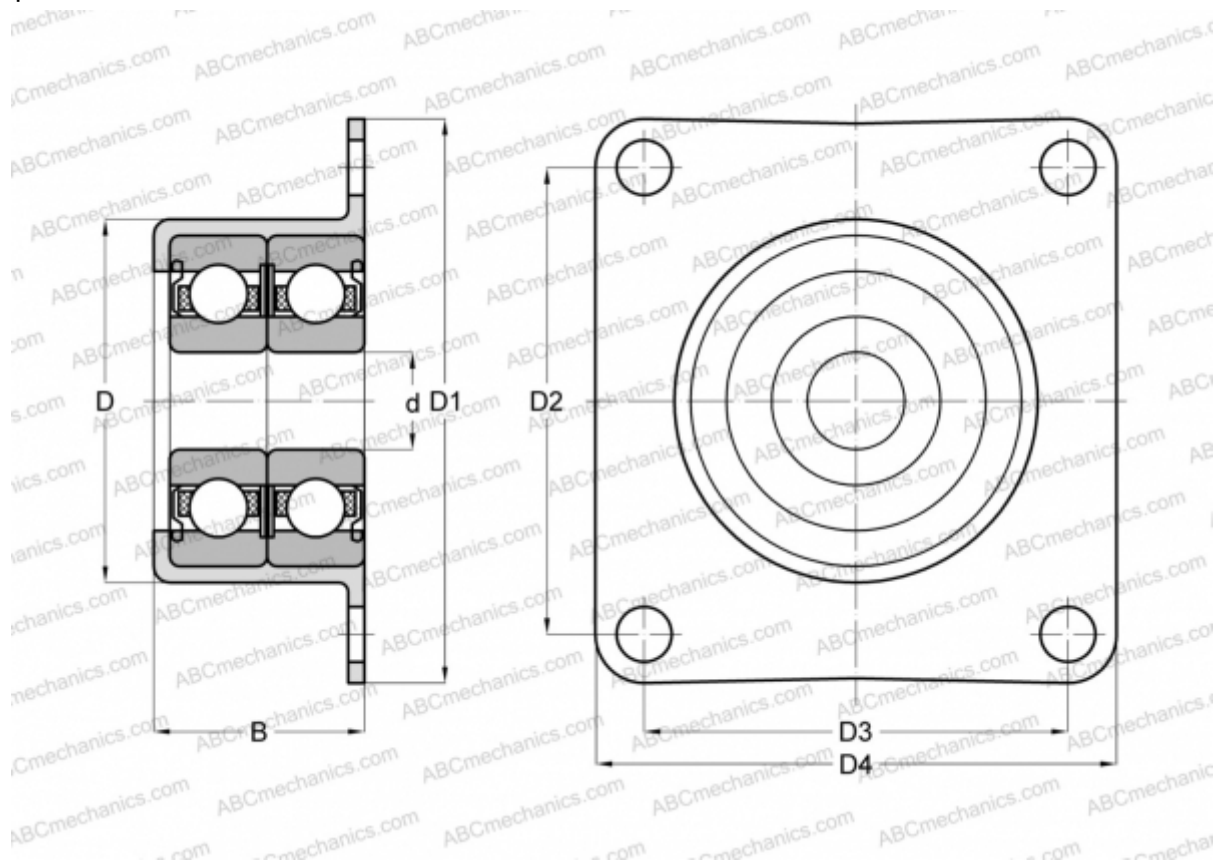

Technical specification

DIMENSIONS, MM

d	15,000
D	38,450
D1	51,000
D2	39,000
D3	35,000
D4	47,000
B	24,000

WEIGHT, KG 0,140

MANUFACTURER [INA](#)