

ZKLR 2060 2RS INA

Axial angular contact ball bearing

TYPE: Ball bearings, Axial angular contact ball bearing, Unit, Series ZKLR, double direction, with flange, lip seals on both side

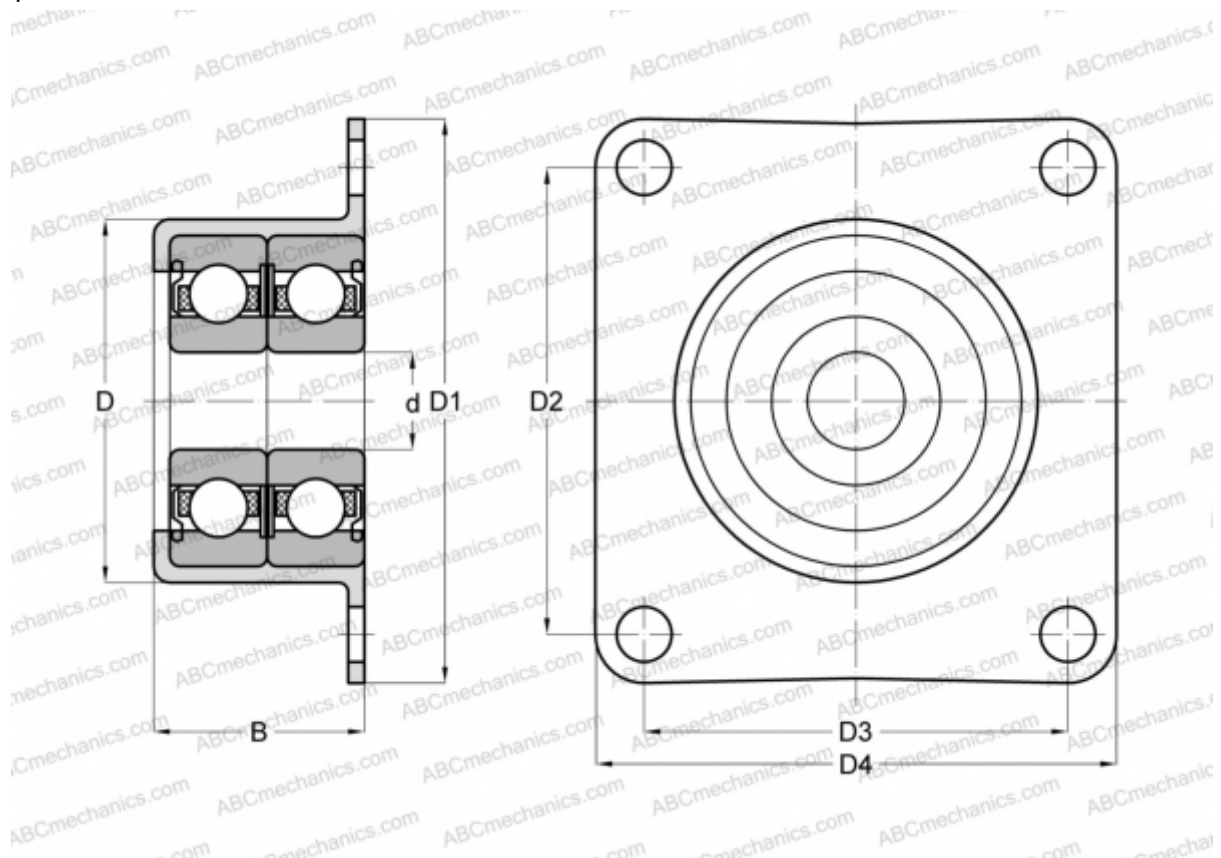

Technical specification

DIMENSIONS, MM

d	20,000
D	50,450
D1	60,000
D2	47,000
D3	47,000
D4	60,000
B	30,000

WEIGHT, KG 0,300

MANUFACTURER [INA](#)