

## RAE17-NPP-B INA

Insert bearings

TYPE: Ball bearings, Radial insert bearings, With eccentric locking collar, Spherical outer ring, Series RAE...-NPP-B(INA), seals on both side

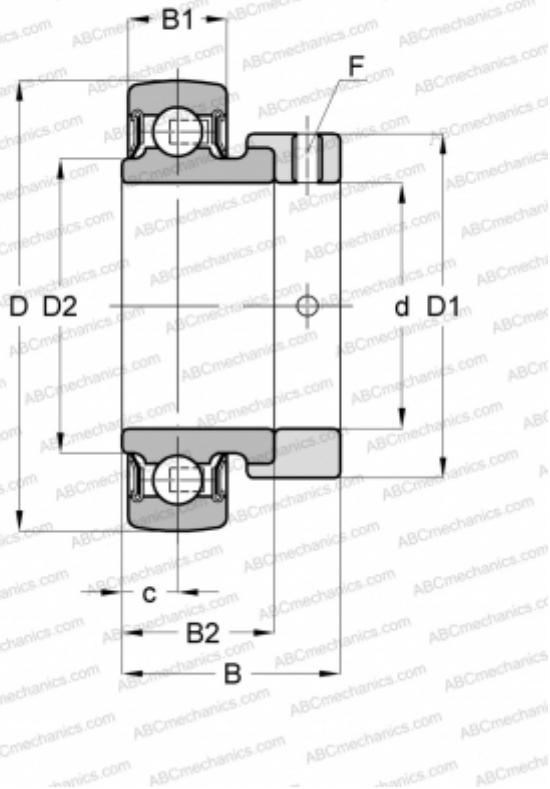

### Technical specification

#### DIMENSIONS, MM

d	17,000
D	40,000
D1	28,000
D2	23,000
B	28,600
B1	12,000
B2	19,000
c	6,500
F	3

#### WEIGHT, KG

0,100

#### MANUFACTURER

[INA](#)

#### REPLACES

RAE17-XL-NPP-B