

RAE25-NPP-B INA

Insert bearings

TYPE: Ball bearings, Radial insert bearings, With eccentric locking collar, Spherical outer ring, Series RAE...-NPP-B(INA), seals on both side

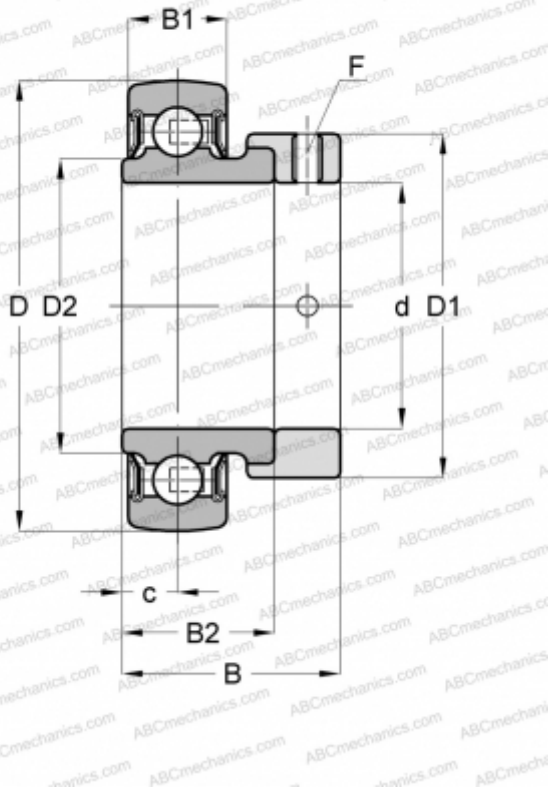

Technical specification

DIMENSIONS, MM

d	25,000
D	52,000
D1	37,500
D2	30,500
B	31,000
B1	15,000
B2	21,400
c	7,500
F	3

WEIGHT, KG

0,190

MANUFACTURER

[INA](#)

REPLACES

RAE25-XL-NPP-B