

## RAE30-NPP-B INA

Insert bearings

TYPE: Ball bearings, Radial insert bearings, With eccentric locking collar, Spherical outer ring, Series RAE...-NPP-B(INA), seals on both side

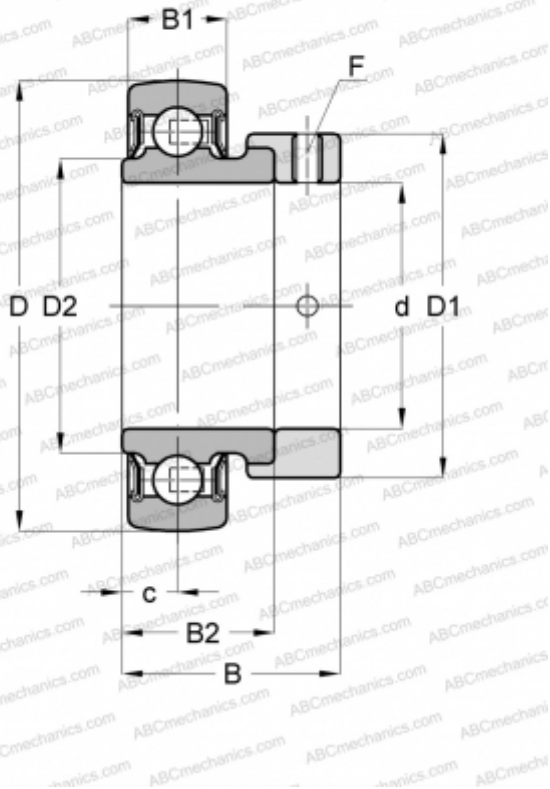

### Technical specification

#### DIMENSIONS, MM

d	30,000
D	62,000
D1	44,000
D2	37,400
B	35,800
B1	18,000
B2	23,800
c	9,000
F	4

#### WEIGHT, KG

0,320

#### MANUFACTURER

[INA](#)

#### REPLACES

RAE30-XL-NPP-B