

RAE35-NPP-B INA

Insert bearings

TYPE: Ball bearings, Radial insert bearings, With eccentric locking collar, Spherical outer ring, Series RAE...-NPP-B(INA), seals on both side

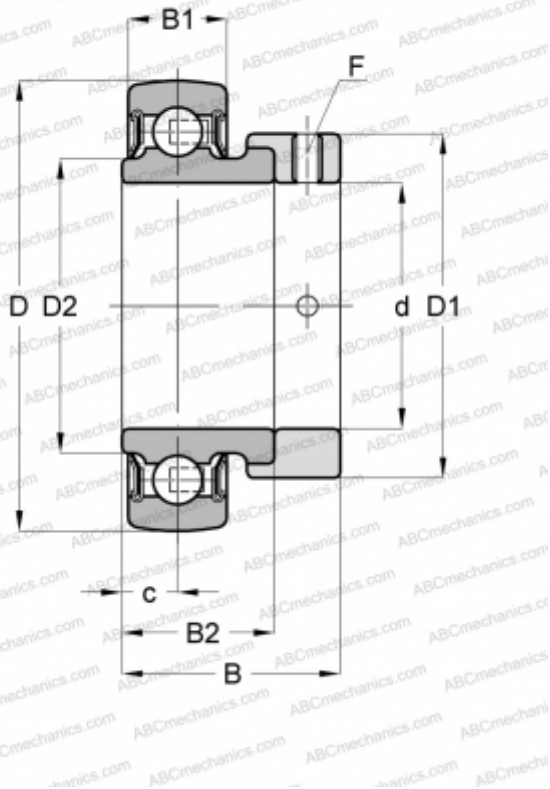

Technical specification

DIMENSIONS, MM

d	35,000
D	72,000
D1	51,000
D2	44,600
B	39,000
B1	19,000
B2	25,400
c	9,500
F	5

WEIGHT, KG

0,470

MANUFACTURER

[INA](#)

REPLACES

RAE35-XL-NPP-B