

RAE45-NPP-B INA

Insert bearings

TYPE: Ball bearings, Radial insert bearings, With eccentric locking collar, Spherical outer ring, Series RAE...-NPP-B(INA), seals on both side

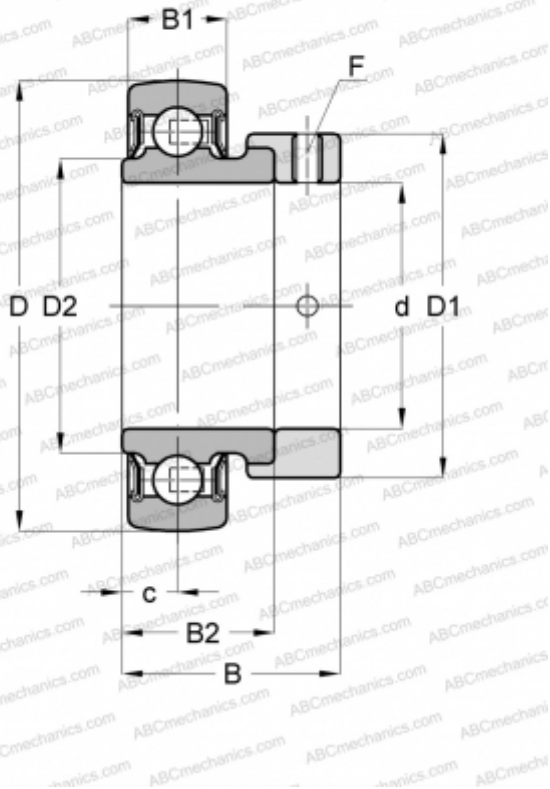

Technical specification

DIMENSIONS, MM

d	45,000
D	85,000
D1	63,000
D2	54,300
B	43,800
B1	22,000
B2	30,200
c	11,000
F	5

WEIGHT, KG

0,700

MANUFACTURER

[INA](#)

REPLACES

RAE45-XL-NPP-B