

## RAE50-NPP-B INA

Insert bearings

TYPE: Ball bearings, Radial insert bearings, With eccentric locking collar, Spherical outer ring, Series RAE...-NPP-B(INA), seals on both side

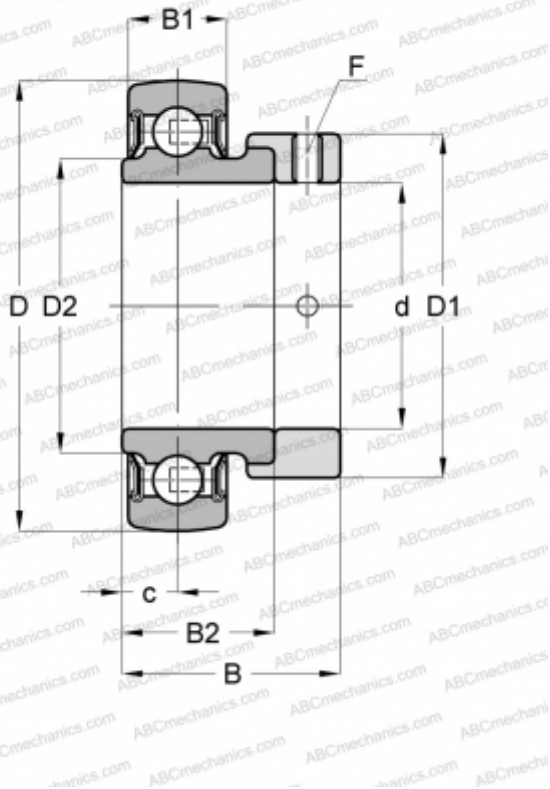

### Technical specification

#### DIMENSIONS, MM

d	50,000
D	90,000
D1	69,000
D2	59,400
B	43,800
B1	22,000
B2	30,200
c	11,000
F	5

#### WEIGHT, KG

0,770

#### MANUFACTURER

[INA](#)

#### REPLACES

RAE50-XL-NPP-B