

GE55-KRR-B INA

Insert bearings

TYPE: Ball bearings, Radial insert bearings, With eccentric locking collar, Spherical outer ring, Series GE..-KRR-B(INA), seals on both side

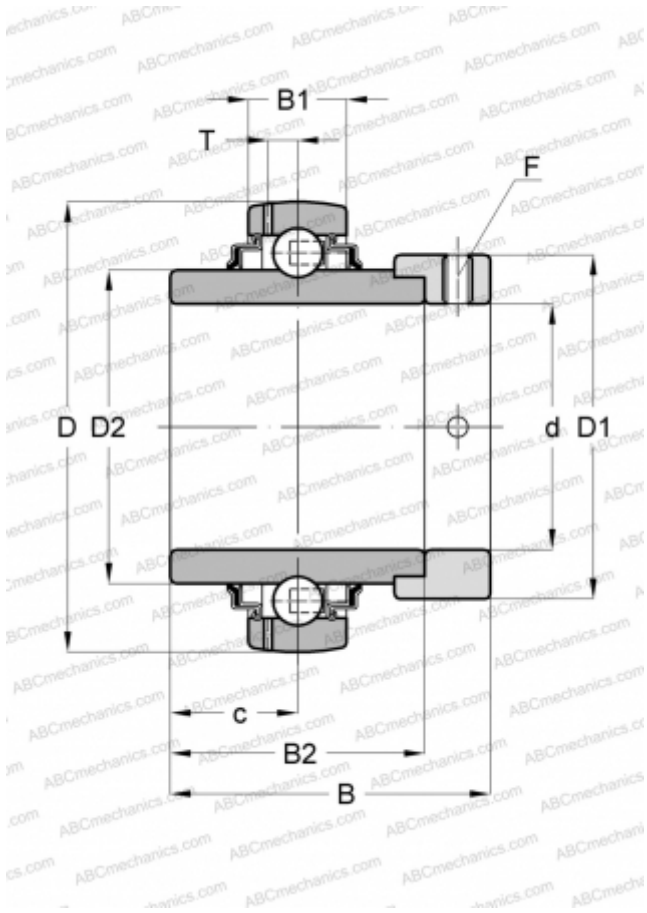

Technical specification

DIMENSIONS, MM

d	55,000
D	100,000
D1	76,000
D2	69,800
B	71,400
B1	25,000
B2	55,500
c	27,800
T	7,000
F	5

WEIGHT, KG

1,370

MANUFACTURER

[INA](#)

REPLACES

GE55-XL-KRR-B