

## GE80-KRR-B INA

Insert bearings

TYPE: Ball bearings, Radial insert bearings, With eccentric locking collar, Spherical outer ring, Series GE..-KRR-B(INA), seals on both side

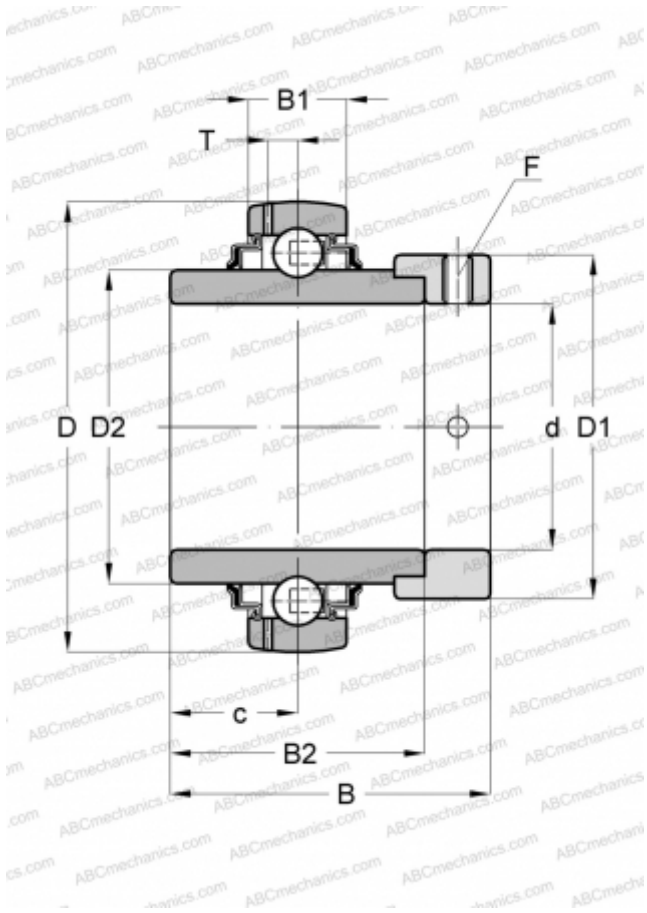

### Technical specification

#### DIMENSIONS, MM

d	80,000
D	140,000
D1	108,000
D2	97,000
B	70,700
B1	30,000
B2	53,200
c	23,400
T	8,800
F	6

#### WEIGHT, KG

2,790

#### MANUFACTURER

[INA](#)

#### REPLACES

GE80-XL-KRR-B