

GE25-KRR-B-FA101 INA

Insert bearings

TYPE: Ball bearings, Radial insert bearings, With eccentric locking collar, Spherical outer ring, Series GE..-KRR-B(INA), seals on both side, for high and low temperature (-40+180)

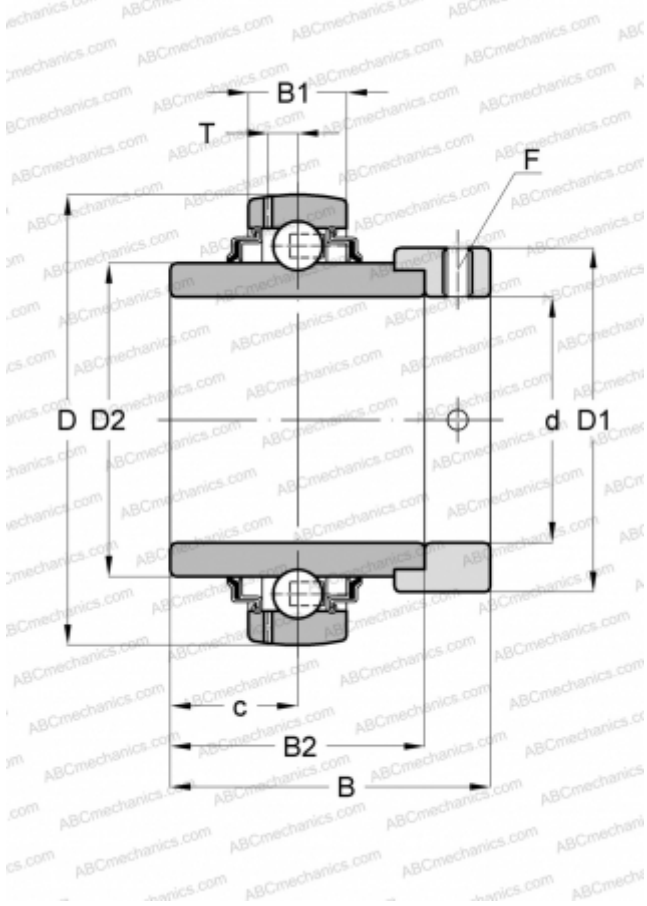

Technical specification

DIMENSIONS, MM

d	25,000
D	52,000
D1	37,500
D2	33,800
B	44,500
B1	15,000
B2	34,900
c	17,500
T	3,900
F	3

WEIGHT, KG

0,240

MANUFACTURER

[INA](#)

REPLACES

GE25-XL-KRR-B-FA101