

## GE25-KRR-B-FA125.5 INA

Insert bearings

TYPE: Ball bearings, Radial insert bearings, With eccentric locking collar, Spherical outer ring, Series GE..-KRR-B(INA), seals on both side, corrosion resistant

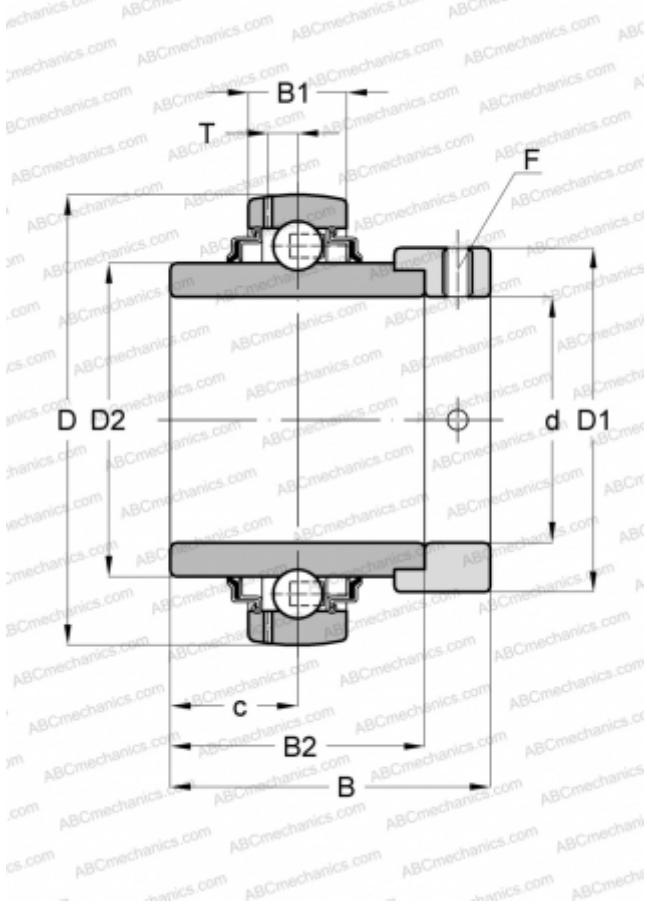

### Technical specification

#### DIMENSIONS, MM

d	25,000
D	52,000
D1	37,500
D2	33,800
B	44,500
B1	15,000
B2	34,900
c	17,500
T	3,900
F	3

#### WEIGHT, KG

0,250

#### MANUFACTURER

[INA](#)

#### REPLACES

GE25-XL-KRR-B-FA125.5