

## GE50-KRR-B-FA164 INA

Insert bearings

TYPE: Ball bearings, Radial insert bearings, With eccentric locking collar, Spherical outer ring, Series GE..-KRR-B(INA), seals on both side, for high temperature (to +250)

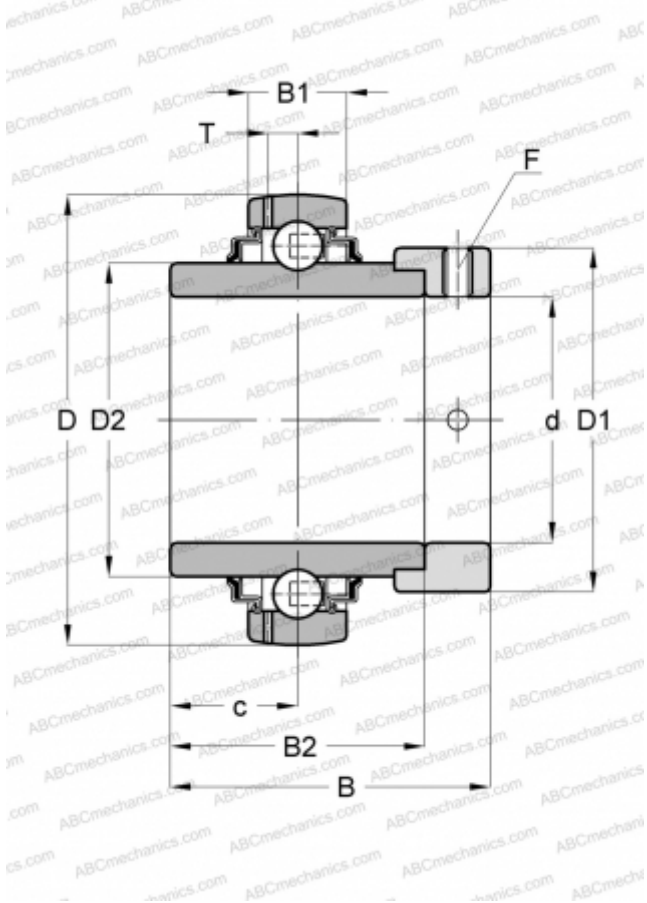

### Technical specification

#### DIMENSIONS, MM

d	50,000
D	90,000
D1	69,000
D2	62,800
B	62,800
B1	22,000
B2	49,200
c	24,600
T	6,900
F	5

#### WEIGHT, KG

0,990

#### MANUFACTURER

[INA](#)

#### REPLACES

GE50-XL-KRR-B-FA164