

## GE60-KRR-B-FA164 INA

Insert bearings

TYPE: Ball bearings, Radial insert bearings, With eccentric locking collar, Spherical outer ring, Series GE..-KRR-B(INA), seals on both side, for high temperature (to +250)

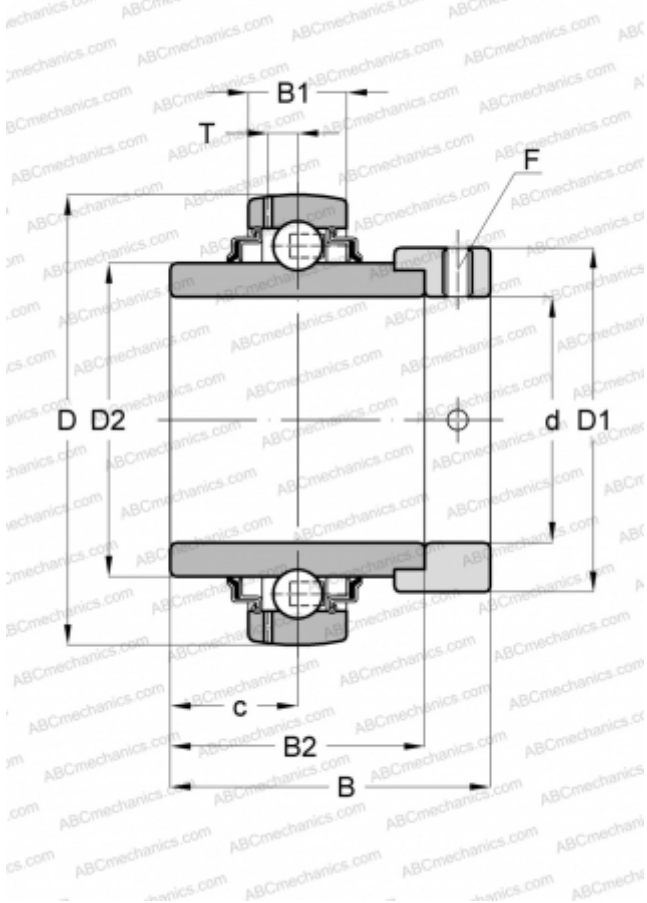

### Technical specification

#### DIMENSIONS, MM

d	60,000
D	110,000
D1	84,000
D2	76,500
B	77,900
B1	24,000
B2	61,900
c	31,000
T	7,200
F	5

#### WEIGHT, KG

1,800

#### MANUFACTURER

[INA](#)

#### REPLACES

GE60-XL-KRR-B-FA164