

E35-KRR-B INA

Insert bearings

TYPE: Ball bearings, Radial insert bearings, With eccentric locking collar, Spherical outer ring, Seals on both side, R seal, without re-relubrication

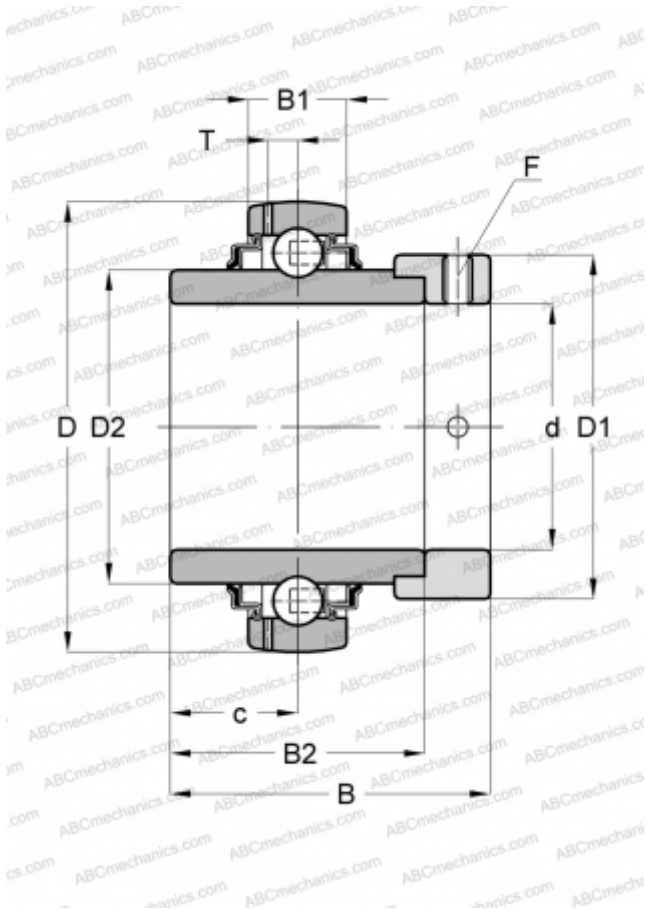

Technical specification

DIMENSIONS, MM

d	35,000
D	72,000
D1	51,000
B	51,300
B1	19,000
B2	37,700
c	18,800
F	5

MANUFACTURER

[INA](#)

CALCULATION DATA

Basic dynamic load rating, C	25,500 kN
Basic static load rating, Co	15,300 kN
Operating temperature min	-20 °C
Operating temperature max	120 °C

REPLACES

E35-XL-KRR-B