

GNE30-KRR-B INA

Insert bearings

TYPE: Ball bearings, Radial insert bearings, With eccentric locking collar, Spherical outer ring, Series GNE..-KRR-B(INA), seals on both side

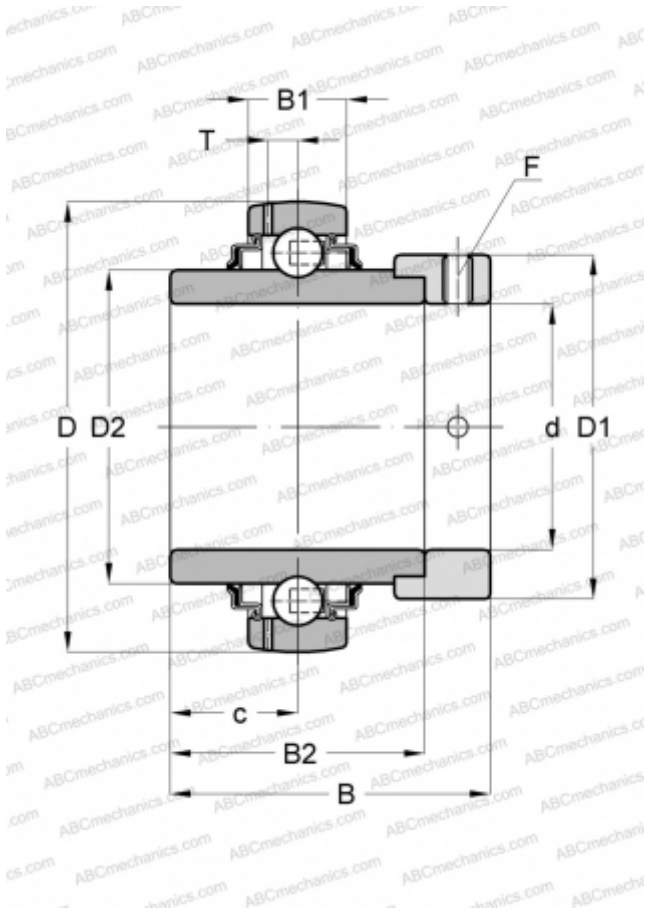

Technical specification

DIMENSIONS, MM

d	30,000
D	72,000
D1	51,000
D2	44,000
B	50,200
B1	20,000
B2	36,600
c	17,500
T	6,200
F	5

WEIGHT, KG

0,630

MANUFACTURER

[INA](#)

REPLACES

GNE30-XL-KRR-B