

GNE60-KRR-B INA

Insert bearings

TYPE: Ball bearings, Radial insert bearings, With eccentric locking collar, Spherical outer ring, Series GNE..-KRR-B(INA), seals on both side

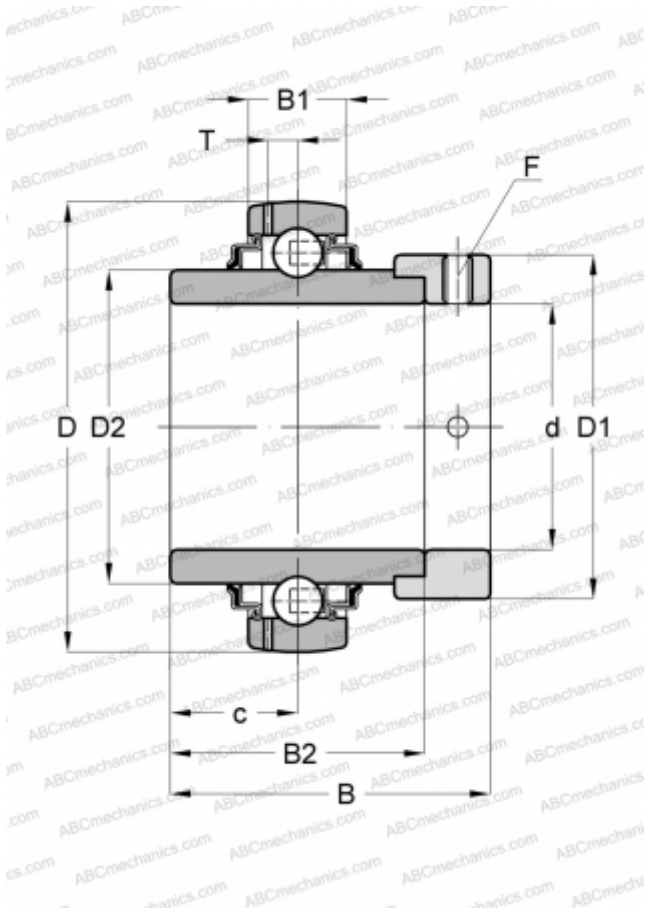

Technical specification

DIMENSIONS, MM

d	60,000
D	130,000
D1	89,000
D2	79,400
B	68,000
B1	33,000
B2	52,000
c	23,000
T	11,200
F	5

WEIGHT, KG

2,970

MANUFACTURER

[INA](#)

REPLACES

GNE60-XL-KRR-B