

GNE70-KRR-B INA

Insert bearings

TYPE: Ball bearings, Radial insert bearings, With eccentric locking collar, Spherical outer ring, Series GNE..-KRR-B(INA), seals on both side

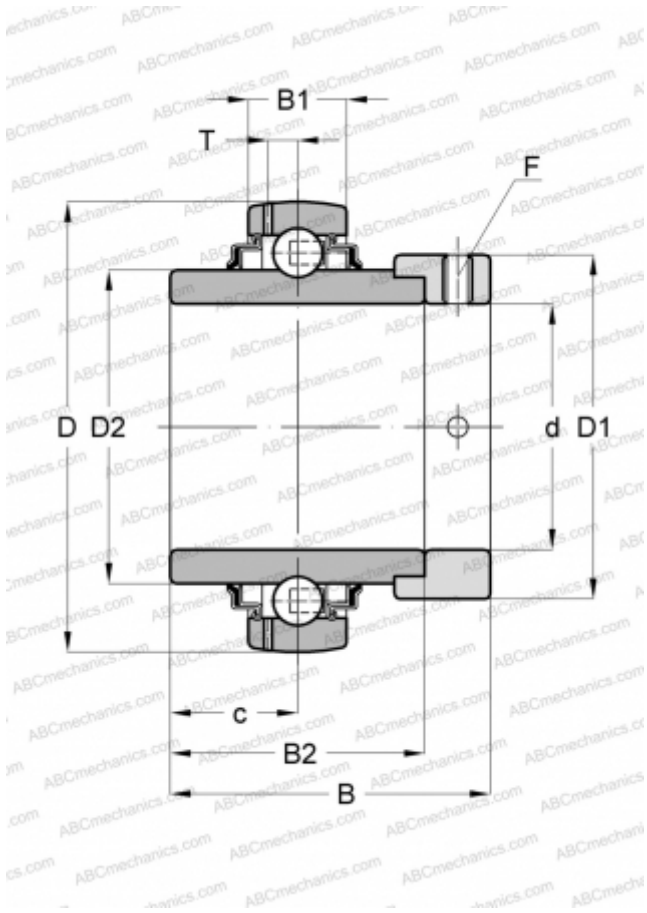

Technical specification

DIMENSIONS, MM

d	70,000
D	150,000
D1	102,000
D2	92,200
B	75,500
B1	37,000
B2	58,000
c	26,000
T	12,000
F	6

WEIGHT, KG

3,810

MANUFACTURER

[INA](#)

REPLACES

GNE70-XL-KRR-B