

GNE80-KRR-B INA

Insert bearings

TYPE: Ball bearings, Radial insert bearings, With eccentric locking collar, Spherical outer ring, Series GNE..-KRR-B(INA), seals on both side

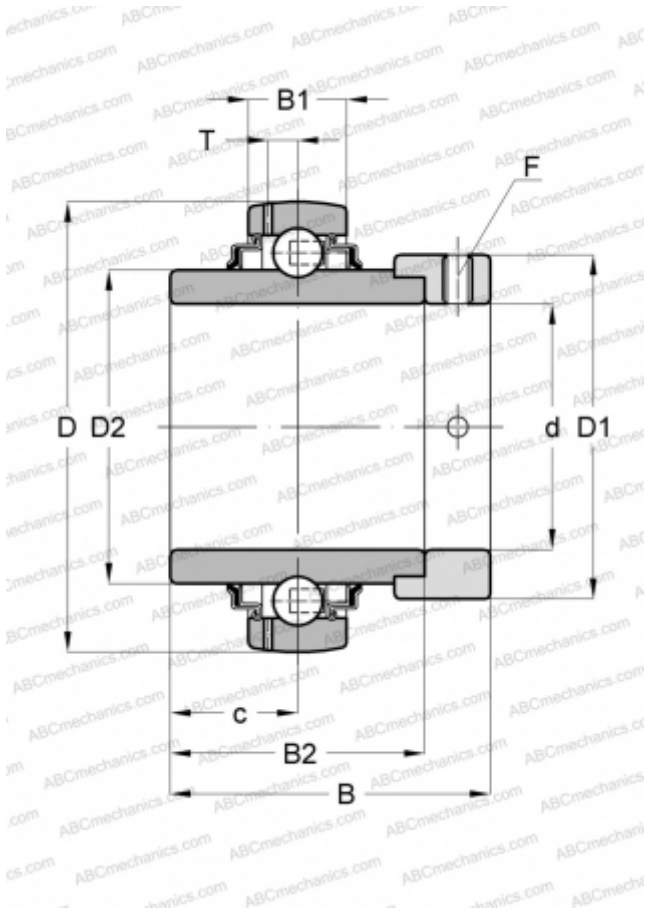

Technical specification

DIMENSIONS, MM

d	80,000
D	170,000
D1	108,000
D2	109,000
B	93,600
B1	41,000
B2	73,000
c	34,000
T	13,200
F	6

WEIGHT, KG

7,100

MANUFACTURER

[INA](#)

REPLACES

GNE80-XL-KRR-B