

GE20-KTT-B INA

Insert bearings

TYPE: Ball bearings, Radial insert bearings, With eccentric locking collar, Spherical outer ring, Series GE..-KTT-B(INA), seals on both side

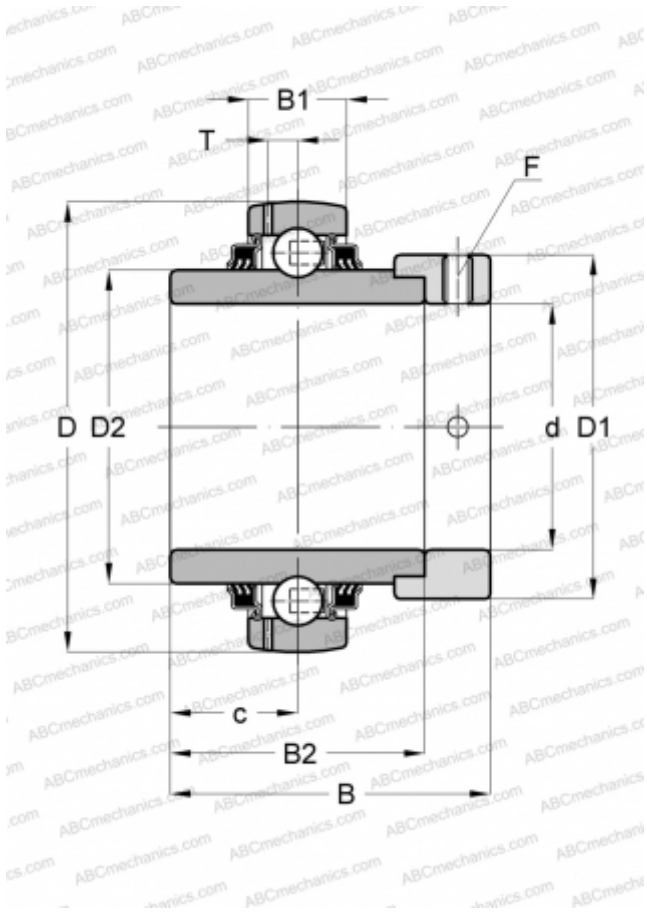

Technical specification

DIMENSIONS, MM

d	20,000
D	47,000
D1	33,000
D2	27,600
B	43,700
B1	14,000
B2	34,100
c	17,100
T	4,000
F	3

WEIGHT, KG

0,190

MANUFACTURER

[INA](#)

REPLACES

GE20-XL-KTT-B