

GE30-KTT-B INA

Insert bearings

TYPE: Ball bearings, Radial insert bearings, With eccentric locking collar, Spherical outer ring, Series GE..-KTT-B(INA), seals on both side

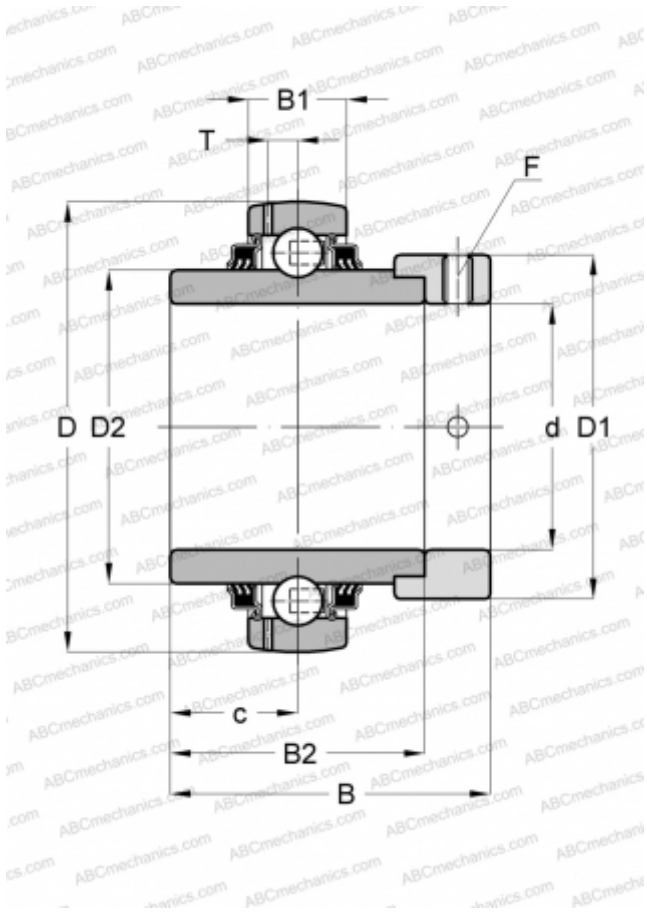

Technical specification

DIMENSIONS, MM

d	30,000
D	62,000
D1	44,000
D2	40,200
B	48,500
B1	18,000
B2	36,500
c	18,300
T	4,700
F	4

WEIGHT, KG

0,380

MANUFACTURER

[INA](#)

REPLACES

GE30-XL-KTT-B